

**RAVEN**

*Simply improving your position.<sup>SM</sup>*

# Installation & Operation Manual



**Viper Pro™**

## ***Disclaimer***

---

While every effort has been made to ensure the accuracy of this document, Raven Industries assumes no responsibility for omissions and errors. Nor is any liability assumed for damages resulting from the use of information contained herein.

Raven Industries shall not be held responsible or liable for the effects of atmospheric conditions and sunspot activity on the performance of our products. Raven Industries cannot guarantee the accuracy, integrity, continuity, or availability of the GPS signal from the U.S. Department of Defense/NAVSTAR GPS satellites, the OmniSTAR correction service, or the WAAS correction service. Raven Industries accepts no responsibility for the use of the signal for other than the stated purpose.

Raven Industries shall not be responsible or liable for incidental or consequential damages or a loss of anticipated benefits or profits, work stoppage or loss, or impairment of data arising out of the use, or inability to use, this system or any of its components.

---

<b>Chapter 1</b>	<b><i>Introduction</i></b> .....	<b>1</b>
	Viper Pro Features .....	2
	Speed Compensated Product Control and Datalogging .....	2
	Variable Rate Application (VRA) .....	2
	On-Screen Guidance .....	2
	Optional Features .....	3
	The Viper Pro Interface .....	3
	Active Matrix Transflective Touch Screen .....	3
	Front Panel .....	5
	File Transfer .....	5
	Rear Panel .....	6
	Viper Pro Care and Use .....	6
<b>Chapter 2</b>	<b><i>Installation, Start Up &amp; Registration</i></b> .....	<b>7</b>
	Overview of the Installation Process .....	7
	Kit Contents .....	8
	Mounting and Installation .....	9
	Mounting the Viper Pro Console .....	9
	DGPS Receiver Connection .....	9
	Power Connection .....	10
	Start Up .....	12
	Touch Screen Calibration Wizard .....	14
	Registering Your Viper Pro System .....	15
	Viper Pro Features .....	15
	To register your Viper Pro: .....	15
<b>Chapter 3</b>	<b><i>CAN (Controller Area Network) Setup</i></b> .....	<b>21</b>
	Overview of a Raven CANbus System .....	21
	Raven CAN System Installation .....	21
	Best Installation Practices .....	22
	Wiring Power to a CANbus System .....	23
	CAN Node Off-line Errors .....	26
	Adding Nodes to the CAN System .....	26
	Detecting CANbus Nodes .....	27
	CAN Initialization Results .....	27
	Selecting a New Controller .....	27
	Re-Addressing Product Nodes .....	28
	Programming Nodes on the CANbus System .....	29
	Boom Cals .....	30
	Miscellaneous Settings Area .....	31
	Miscellaneous Settings Screen .....	32
	Node Version Information .....	35
	Data Box 1 .....	36

**Table of Contents**

---

Node Settings Screen (Page 1) ..... 37  
Node Settings Screen (Page 2) ..... 38  
Data Box 2 ..... 39  
    Data Box 2 Displays ..... 40  
    Node Settings Screen (Page 1) ..... 41  
    Node Settings Screen (Page 2) ..... 45  
    Node Settings Screen (Page 3) ..... 48  
Pressure Area ..... 49  
    Dual Pressure ..... 49  
    Calibrating the Pressure Transducer Using an Analog Gauge ..... 49  
    Entering a Setting with no Analog Gauge ..... 50  
Application Area ..... 50  
    Valve Type ..... 51  
    Application Type ..... 51  
Tally Registers ..... 52  
    Resetting the Tally Registers ..... 53  
    Setting or Resetting Distance and Individual Nodes ..... 53  
Alarms ..... 54

**Chapter 4   *Navigating the Viper Pro Interface*..... 57**

Main Screen Features ..... 57  
    Profile ..... 58  
    Current Heading ..... 59  
    Speed ..... 59  
    Pressure ..... 59  
    Map Area ..... 60  
    Screen Tool Icons ..... 60  
    Tabs ..... 62  
    Application Rates ..... 62  
    Booms ..... 63  
    System Status Icons ..... 64  
    GPS Status Indicator ..... 64  
    Product Control Status ..... 66  
    AutoBoom™ Status Indicator ..... 66  
    Display Data ..... 67  
Wireless Communication Status ..... 68  
    SmarTrax™ Status Indicator ..... 68  
Tabs ..... 69  
    Main Tab ..... 69  
    Guide Tab ..... 71  
    Rx+Cov+Scout Tab ..... 71  
    Rx Tab ..... 72  
    Cov Tab ..... 73  
    Scout Tab ..... 74

Marking a Field Boundary .....	74
Importing a Field Boundary .....	76
AccuBoom™ Tab .....	77
Menu .....	78
Exit Button .....	78
About Button .....	79
Display Mode and Brightness .....	80
Web Button .....	80
Setup Button .....	81
File Maintenance .....	81
Start Job .....	81
Setup Menu .....	82
Registration Keys and Feature Activation .....	82
Maps .....	82
Street Maps .....	83
Scout Maps .....	84
Coverage Maps .....	86
Prescription (Rx) Maps .....	87
Local Settings .....	92
Language .....	92
Profile Configuration .....	92
Display Units Configuration .....	93
Time Zone Configuration .....	94
Serial Communication Port Setup .....	94
GPS Comm Port Setup .....	95
Console Comm Port Setup .....	97
Auxiliary Comm Port Setup .....	97
Weather Module Setup .....	97
Configuring Viper Pro for Lightbar Guidance .....	98
Boom and Implement Setup .....	100
Setting up Booms .....	100
Boom Mapping .....	102
Advanced Settings .....	104
<b>Chapter 5 Using the Viper Pro System.....</b>	<b>107</b>
Jobs .....	107
New Jobs .....	108
Product Application .....	108
Swath Guidance .....	109
AccuBoom™ Control .....	109
Product Chaining .....	110
Starting a New Job .....	110
Pausing a Job .....	114
Restarting a Paused Job .....	114

**Table of Contents**

---

Existing Jobs .....	114
Viewing an Existing Job .....	114
Adding to an Existing Job .....	114
Tiered Booms .....	115
Enabling Tiered Booms .....	116
Application Reports .....	117
Customer Information .....	117
Field Information .....	118
Field Conditions .....	118
Weather Information .....	119
Applicator Information .....	119
Vehicle Information .....	120
Product Information .....	120
Ingredient Information .....	121
Report Notes Information .....	121
Creating an Application Report .....	122
<b>Chapter 6    <i>Product Chaining</i>.....</b>	<b>123</b>
Enabling Product Chaining .....	123
Using Product Chaining .....	125
Display Data .....	126
Miscellaneous Messages .....	126
<b>Chapter 7    <i>Using AccuBoom™</i>.....</b>	<b>129</b>
AccuBoom™ Control Setup .....	131
Configuring AccuBoom™ Control .....	133
AccuBoom™ Boom Disable .....	133
AccuBoom™ Aggressiveness Factor .....	134
Enabling AccuBoom™ Override .....	135
AccuBoom™ Spray/No-Spray Mapping .....	135
Standard AccuBoom™ Method .....	136
Create AccuBoom™ No-Spray Map Method .....	136
Load AccuBoom™ No-Spray Map Method .....	137
Create Map From Field Boundary Method .....	137
Changing Spray/No-Spray Default Colors .....	137
AccuBoom™ Spray/No-Spray Maps .....	138
How to Create a Spray/No-Spray Map .....	138
<b>Chapter 8    <i>Using AutoBoom™</i>.....</b>	<b>141</b>
AutoBoom™ Status Display .....	142

<b>Chapter 9</b>	<b><i>Viper Pro Guidance</i></b> .....	<b>143</b>
Guidance Views	.....	146
Swathing Patterns	.....	147
Setting the Straight A-B Line Pattern	.....	147
Set B by Heading	.....	148
Setting the Fixed Contour Pattern	.....	149
Setting the Last Pass Pattern	.....	150
Setting the Pivot Pattern	.....	150
Using the Guide Tab	.....	151
Screen Icons	.....	154
A-B Lines	.....	154
Saving an A-B Line	.....	155
Loading an A-B Line	.....	156
Nudge Feature	.....	157
Configuring Nudge Settings	.....	157
Using the Nudge Feature	.....	158
<b>Chapter 10</b>	<b><i>File Maintenance</i></b> .....	<b>159</b>
Overview	.....	159
File Maintenance	.....	159
Preparing a USB Thumb Drive for File Maintenance	.....	160
Misc Folder Sub-folders	.....	161
Performing File Maintenance	.....	163
Wireless File Transfer	.....	163
Uploading Prescription Maps from a USB Thumb Drive	.....	164
USB File Transfer and Advanced File Maintenance	.....	164
Initialize External USB Drive	.....	167
Automatic File Maintenance	.....	167
Clone or Restore Settings	.....	168
Select External Drive	.....	168
<b>Chapter 11</b>	<b><i>Rbin Viewer</i></b> .....	<b>169</b>
Downloading Rbin Viewer	.....	169
Downloading Rbin Software	.....	169
Installing the Rbin Viewer	.....	171
To Install the Rbin viewer:	.....	171
Viewing Rbin Files	.....	173
To Open an Rbin Report	.....	173
Exporting Shapefiles	.....	175
To Export a Shapefile	.....	175
Toolbar Options	.....	176
To select the coverage display options:	.....	176
To change coverage map colors:	.....	177

**Table of Contents**

---

Rbin Options ..... 177

- To Change the Units of Measure ..... 178
- To Change the Layout ..... 178
- To Change the Language: ..... 179
- Enabling Manual Console Display ..... 180
- To Enable Manual Console Display ..... 180
- Export Settings ..... 180
- To Change The Export Settings: ..... 181
- Editing an Rbin Report ..... 181
- To Edit an Rbin Report ..... 182
- Reset History ..... 184
- To Reset the Edit History ..... 184

**Chapter 12 Troubleshooting the Viper Pro System ..... 187**

- Viper Pro Troubleshooting Information ..... 187
  - General Issues ..... 187
  - Setup Issues ..... 188
  - Job Issues ..... 189
  - Rx Map Issues ..... 190
  - Coverage Map Issues ..... 190
- Error Messages ..... 191
  - General Error Messages ..... 191
  - Setup Error Messages ..... 191
  - Job Error Messages ..... 192
  - Variable Rate Control (VRC) Error Messages ..... 192
  - GPS Error Messages ..... 193
- CAN Troubleshooting ..... 194



---

**APPENDIX**

<b>Appendix A</b>	<b><i>System Diagrams</i></b> .....	<b>195</b>
<b>Appendix B</b>	<b><i>Understanding Viper Pro Files</i></b> .....	<b>201</b>
<b>Appendix C</b>	<b><i>Calculating the Boom Width (Calibration) for Liquid Applications</i></b> .....	<b>205</b>
<b>Appendix D</b>	<b><i>Calculating and Verification of Spreader Constant</i></b> .....	<b>207</b>
<b>Appendix E</b>	<b><i>Calculating Speed Calibration</i></b> .....	<b>209</b>
<b>Appendix F</b>	<b><i>Calculating Calibrations for Liquid and Granular Applications</i></b> .....	<b>211</b>
<b>Appendix G</b>	<b><i>Testing Extension Cables</i></b> .....	<b>215</b>
<b>Appendix H</b>	<b><i>Updating CAN Nodes on the Viper Pro Console</i></b> .....	<b>219</b>
<b>Appendix I</b>	<b><i>Using the Front Panel Program with the Viper Pro System</i></b> .....	<b>223</b>
<b>Appendix J</b>	<b><i>Controlling Spinner RPM</i></b> .....	<b>227</b>
<b>Appendix K</b>	<b><i>External Serial Rate Control</i></b> .....	<b>229</b>
<b>Appendix L</b>	<b><i>Weather Station</i></b> .....	<b>231</b>
<b>Appendix M</b>	<b><i>Wireless Communications &amp; Remote Service</i></b> .....	<b>235</b>



# CHAPTER

# 1

# *Introduction*

Congratulations on your purchase of the Raven Viper Pro precision application management system!

Viper Pro is a multi-purpose precision tool offering the latest technology in precision agriculture with features including product application control, field mapping and application reports, as well as in-field guidance via a connected DGPS (Differential Global Positioning System) receiver.

**FIGURE 1. Raven Viper Pro Console**



## *Viper Pro Features*

The following sections offer a brief introduction to the capabilities of the Viper Pro console and some of the optional features available for use with the Viper Pro precision application management system.

### Speed Compensated Product Control and Datalogging

The Viper Pro is capable of controlling up to five products through Product Control Nodes connected to a CANbus system. Viper Pro automatically adjusts the application rate of each product according to the speed of the vehicle, width and status of programmed sections, and a programmed target rate.

The Viper Pro is also capable of monitoring and mapping applications controlled by another Raven Serial Console, such as the Raven SCS 440 or 460 consoles, via a serial connection. Variable Rate capabilities of the Viper Pro may also be used with a Raven Serial Console.

A real-time, as-applied map is displayed on-screen while application and scouting information is logged and saved by the Viper Pro. This “Job” information can then be transferred to a USB flash drive, copied to a home or office PC, and used to create printed reports and coverage maps.

### Variable Rate Application (VRA)

Viper Pro can provide automatic variable-rate control for liquid, granular, spinner control, anhydrous, or injection products. Viper Pro will also datalog and store as-applied data or scouting information. This as-applied information can be used to compare the field prescription to the actual application and provide valuable documentation of the application. The Viper Pro system will store the application report and datalogged information as a very efficient “Rbin” file. See Chapter 10, *File Maintenance*, or Appendix B, *Understanding Viper Pro Files*, for detailed information. Raven provides, at no additional charge, an easy to use Rbin Viewer tool that allows the operator to view and print Viper Pro application reports or export the logged data as a shapefile. The common shapefile format can be used with many application management software packages.

Single Product VRA (Variable Rate Application) comes standard with your Viper Pro system. With the Multi-Product VRA upgrade (P/N 077-0171-152), the Viper Pro system can variable rate up to five products simultaneously.

### On-Screen Guidance

The Viper Pro system provides on-screen 3-D guidance in the form of a Course Direction Indicator (CDI) as well as an on-screen lightbar. The Guidance feature offers Straight A-B, Last Pass, Fixed Contour, and Pivot swath patterns to match your field and application. In addition, GPS information may be sent to an optional Raven external lightbar. See Chapter 9, *Viper Pro Guidance*, for more detailed operation.

---

## Optional Features

In addition to the product application control capabilities of the Viper Pro system, several optional Raven components and systems are available for use with the Viper Pro system.

- AccuBoom™ automatic boom section control systems.
- AccuRow™ automatic planter section control systems.
- Glide Series AutoBoom™ automatic boom height management systems.
- SmarTrax™, SmartSteer™, or QuickTrax™ assisted steering systems.
- TM-1 Tilt Module offers tilt corrected DGPS guidance over rough or hilly terrain.
- WatchDog Sprayer Station for automated weather information collection and reporting.
- Field Hub™ for wireless communication and internet access.
- SCS Sidekick™ direct injection systems for automatic rate control of injected chemicals.

**Note:** Please see Chapter 7, *Using AccuBoom™*, or Chapter 8, *Using AutoBoom™*, for more information on using these features with the Viper Pro console.

The Viper Pro is also capable of integrating into many Raven CANbus control systems or with Raven standard serial interface control consoles and virtually any new or existing DGPS receiver.

Contact your local Raven dealer for more information about these and other optional features and components available for use with the Viper Pro.

---

## *The Viper Pro Interface*

The following sections offer an overview of the user interface features of the Viper Pro console.

### Active Matrix Transflective Touch Screen

The Active Matrix Transflective touch screen allows screen visibility through a wide range of lighting conditions and even in direct sunlight while the touch screen functionality places menus, options, and features literally at the operator's finger tips.

## Chapter 1

The Viper Pro console offers a convenient touch screen interface. Access to various features and options is provided, literally, at the operator's finger tips. Additional setup and information screens are accessible through the Menu.

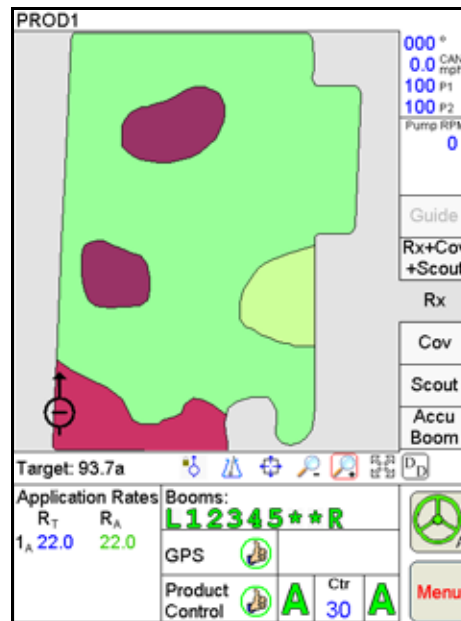

### CAUTION

To avoid damaging the touch screen, do not use sharp objects, such as ball point pens, pocket knives, screwdrivers, etc. on the Viper Pro display.

## Front Panel

The front panel of the Viper Pro provides easy access to the power button and the USB connection. The following is a description of the front panel features of the Viper Pro:

FIGURE 2. Viper Pro Front Panel



Press the Power button to start up the Viper Pro console. The console takes approximately 30 seconds to power up.

	<p style="text-align: center;"><b>NOTICE</b></p> <p>Failure to close a job before turning the console's power off may result in a loss of information for that job. Make sure to properly close any open jobs before shutting down the console.</p>
--	---

A USB Port is conveniently located on the front of the Viper Pro console. Insert a USB flash drive into this port to transfer compatible Viper Pro files.

**Note:** *The USB flash drive must be formatted with the Viper Pro file structure. See Chapter 10, File Maintenance, for setting up the required file structure on your USB flash drive.*

## File Transfer

The Viper Pro features internal memory to store files for current job and field information. The internal memory should not be used for long term storage and files should be periodically transferred to a home or office PC for archiving and printing job reports. When transferring files, use a USB flash drive, or "thumb drive," with at least 256 MB of memory. USB flash drives may be purchased directly from Raven Industries (1 GB USB Flash Drive P/N 524-0002-065) as well as many retail locations.

FIGURE 3. USB Flash Drive



**Note:** *Install the USB flash drive only when you want to transfer files. Do not start the Viper Pro or leave the USB "thumb drive" in the Viper Pro during normal operations.*

## Rear Panel

The following is a brief introduction to the ports and connectors available on the back of the Viper Pro console.

The rear panel offers additional USB Ports as well as a port for connecting an optional wireless router for future wireless capabilities.

FIGURE 4. Viper Pro Rear Panel

---

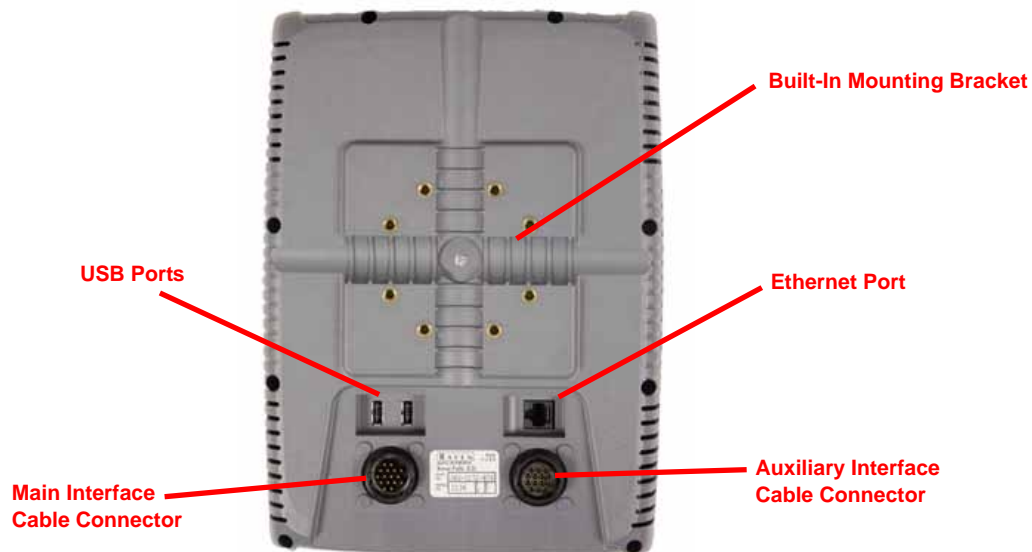

The connectors for the Main and Auxiliary Interface Cables are also located on the back of the Viper Pro.

The console's Part and Serial Numbers, and Revision Letter, are printed on the tag located on the back of the console. Please have this information available should you need to contact customer support.

---

## Viper Pro Care and Use

Refer to the following guidelines for proper care and use of the Viper Pro console.

### CAUTION

- Do not apply any type of liquid or glass cleaner directly to the surface of the touch screen. Harsh chemicals may damage the touch screen. Clean the touch screen and console exterior as needed with a soft cloth dampened with glass cleaner. Apply the cleaner to the cloth and then wipe the screen gently.
- Do not use any type of pointed or sharp instrument on the Viper Pro touch screen. Only your fingertip or approved stylus should be used when interfacing with the console.
- Do not expose the Viper Pro console to precipitation or other forms of liquid.
- Mount the console securely and route cables to prevent pinching or a tripping hazard.
- When temperatures are expected to be below 10° Fahrenheit [-12° Celsius], the Viper Pro console should be removed from the vehicle and stored in a temperature controlled environment.



## CHAPTER

# 2

## *Installation, Start Up & Registration*

### *Overview of the Installation Process*

The following sections are intended as an overview of the Viper Pro installation process. These instructions cover basic installation of the Viper Pro console and supplied components and cabling.

**Note:** *For instructions on installing additional hardware with your Viper Pro, refer to instructions provided with the additional or optional component(s). Instructions for building a CAN (Controller Area Network) System can be found in Chapter 3, CAN (Controller Area Network) Setup. For additional system diagrams, see Appendix A, System Diagrams.*

Basic installation of the Viper Pro system is as follows:

1. Review Kit contents
2. Mounting the Viper Pro console
3. Mounting the DGPS Receiver and Antenna
4. Route and connect Main Interface Cable
5. Connect any optional CAN or GPS components
6. Connect the Main Interface Cable power leads to the vehicle's battery

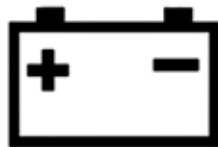

### **CAUTION**

Be sure to follow the instructions for connecting the power leads to the battery carefully. Reversing the power leads may cause damage to the Viper Pro. Be sure to connect the battery leads after all other components have been properly mounted and connected.

## Kit Contents

Before proceeding with the installation of your Viper Pro system, review the following components of your Viper Pro kit;

**TABLE 1. Viper Pro Kit (P/N 117-0171-112)**

<b>Part/Description</b>	<b>Part Number</b>
Console, Viper Pro	063-0172-879
Clamp, Mounting	106-0159-607
Bracket, Mounting	107-0171-415
Knob, Mounting Clamp	309-1000-021
Cable, Main Interface	115-0171-746
Manual, Viper Pro	016-0171-122
Quick Reference Guide, Viper Pro	016-0171-147
<b>Other Available Components</b>	<b>Part Number</b>
Cable, Auxiliary Interface	115-0171-745
Cable, Combo Interface	115-0171-744
Cable, Adapter, Viper to Viper Pro	115-0171-742
CAN Node, Boom/Speed	063-0172-272
CAN Node, Single Product	063-0172-373

**Note:** *If the Viper Pro will be providing product control through a CANbus system, a boom sense/speed node (P/N 063-0172-272) and at least one single product node (P/N 063-0172-373) must be connected to the CANbus.*

## Mounting and Installation

The following procedure will guide you through mounting the Viper Pro console and connecting the required cables.

### Mounting the Viper Pro Console

1. Select a location to mount the Viper Pro console.

Refer to the following requirements when selecting a mounting location for the Viper Pro console:

- The Viper Pro console is not weatherproof. Mount the console inside of the machine's cab or drivers compartment within easy reach of the driver or operator.
  - Securely fasten the Mounting Bracket (P/N 107-0171-415) to a suitable, flat surface. Once mounted, the bracket must provide a stable base for the console and should not impede normal machine operation.
  - The Viper Pro should be mounted in a location where it will not be jarred during normal equipment operation. Keep the console clear of moving elements within the machine's cab.
  - Keep cable routing in mind when selecting a mounting location to avoid tripping hazards or damage to the cable during normal operation.
2. Connect the Main Interface Cable (P/N 115-0171-746) to the back of the console.
  3. Begin routing Main Interface Cable to avoid tripping hazards as well as to protect the cable from kinking or breaking during normal machine operation. The conduit with the red and white leads can be routed to a clean, controlled power source.

	<b>CAUTION</b>
	DO NOT connect the power leads until instructed. The power leads should be connected after all other installation instructions have been completed. Reversing the power leads may cause damage to the console.

### DGPS Receiver Connection

	<b>NOTICE</b>
	Carefully read and follow all installation instructions included with the DGPS Receiver and Antenna and any optional DGPS components before connecting the Viper Pro console or related cabling.

Signal from an DGPS Receiver must be routed into the Viper Pro via the serial connector labeled 'DGPS' on the Main Interface Cable (P/N 115-0171-746). For information on configuring the Viper Pro to receive signal from the connected DGPS Receiver, refer to the *Serial Communication Port Setup* section on page 94.

**FIGURE 1. DGPS Receiver Connection Example  
Viper Pro with Phoenix 200 (Integrated Receiver/Antenna)**

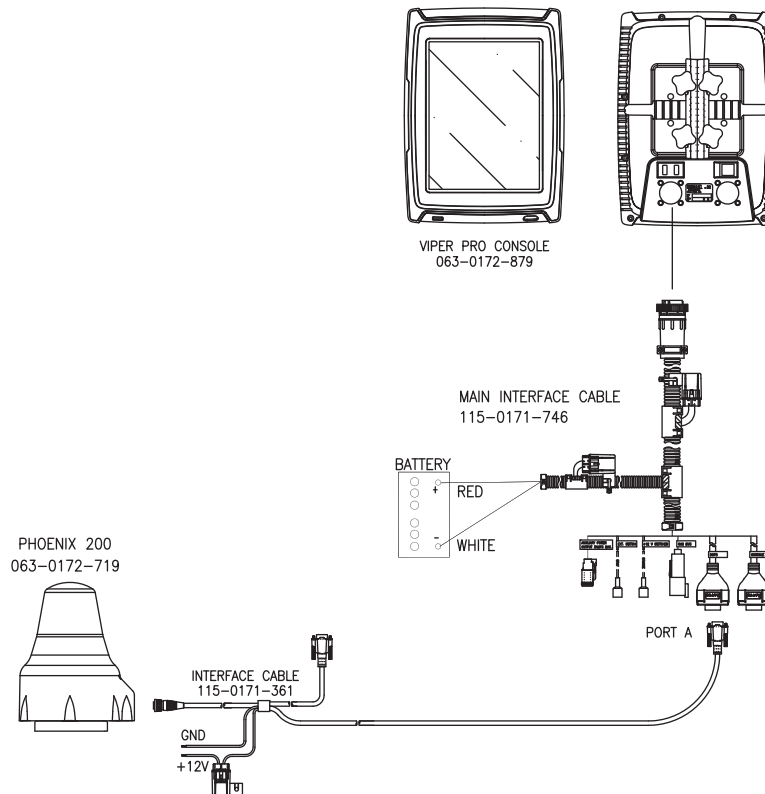

## Power Connection

Ensure that the Viper Pro has been properly mounted and all component cabling has been connected before connecting the Main Interface Cable (P/N 115-0171-746) to power.

1. Route the conduit with red and white leads to the vehicle's battery.
2. Connect red lead wire to the positive battery lead.
3. Connect the white wire to ground.

	<h3>CAUTION</h3>
	<p>Viper Pro consoles with hardware revision A or higher should be connected directly to the vehicle battery.</p> <p>Consoles with no revision ("Rev -" or empty rev box on Viper Pro console tag) should be connected to a clean, controlled power source.</p>

FIGURE 2. Main Interface Cable (P/N 115-0171-746) Power Lead Connection

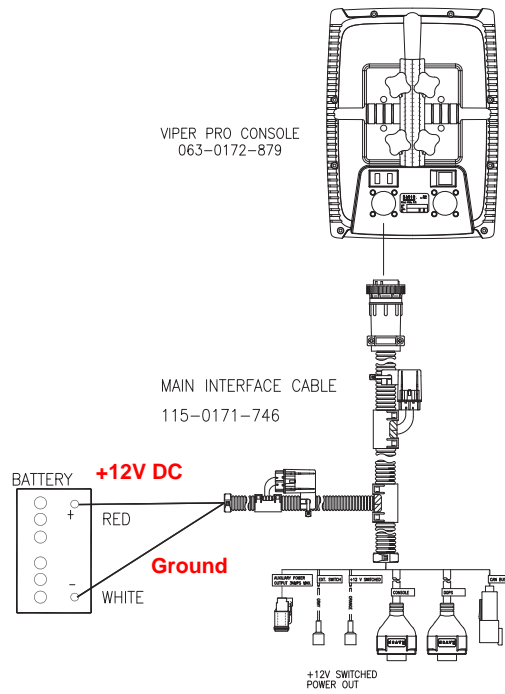

**Note:** Do not connect the orange wire to external power. The orange wire is switched power out of the Viper system. When Viper is powered, +12V DC is applied to the orange wire to power an external device. If more than 1 amp is required from the orange wire, install a relay to switch the higher currents.

FIGURE 3. Relay (P/N 415-1001-009) Terminals

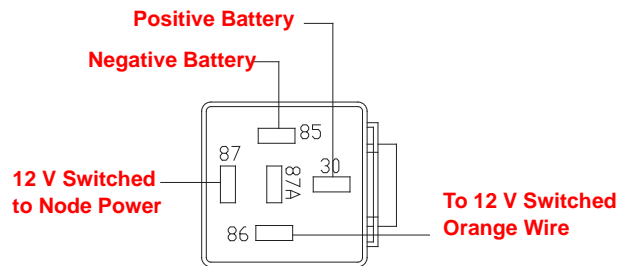

## Start Up

**Note:** Before connecting or using any additional or optional components with the Viper Pro precision application management system, be sure to follow any installation instructions and verify proper installation.

Before powering up the Viper Pro console, check that the console is properly mounted and all power and cable connections have been installed properly as instructed in the previous sections.

Once installation of the Viper Pro precision application management system has been completed and verified, the console may be powered up.

### To start up the Viper Pro:

1. Press the power button on the Viper Pro console. The console will take approximately 2 minutes to power up.

**Note:** Pressing the power button when the following prompt is displayed on-screen will launch the touch screen calibration wizard without displaying the Program Selection Menu.

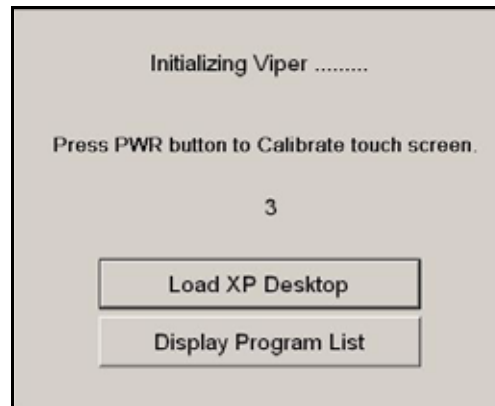

This prompt is displayed for approximately five seconds and may be ignored to display the Program Selection Menu as normal.

- The Program Selection Menu will display if the Viper Pro was powered off at this screen the last time the console was on.

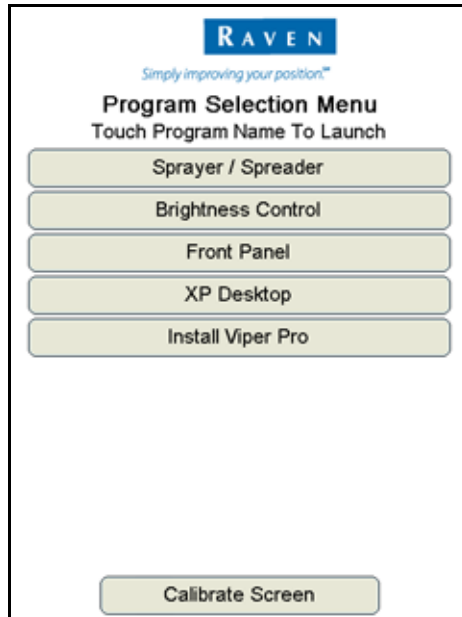

**Note:** To skip the Program Selection Menu next time the Viper Pro is powered up, shutdown the console from the Viper Pro application. Within the Viper Pro application, touch the Menu button in the lower right corner of the screen and select Exit, Shutdown Viper.

Select the:

- **Brightness Control** option to adjust the screen brightness.
  - **Front Panel** option to configure Raven DGPS Receivers directly with the Viper Pro using the Front Panel Program. See Appendix I, *Using the Front Panel Program with the Viper Pro System*, for detailed instructions on setting up and using the Front Panel Program.
  - **XP Desktop** option to view the Windows desktop on the Viper Pro console.
  - **Install Viper Pro** option to install the Viper Pro application. This option is only displayed if a thumb drive containing the Viper Pro startup directory is inserted into the Viper Pro console.
  - **Calibrate Screen** button at the bottom of the screen to begin the touch screen calibration wizard.
- Select the **Sprayer/Spreader** option to launch the Viper Pro precision application management system.
  - If the Viper Pro is set as the CAN Controller, the Viper Pro will attempt to establish communication with the CANbus system. The CAN Initialization Results screen displays the results of CANbus detection.

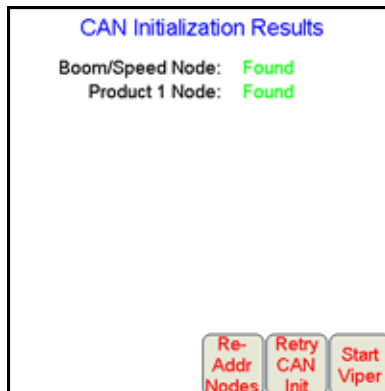

5. If the status of the CAN nodes is displayed properly, touch the **Start Viper** button to finish the start up sequence.

**Note:** Refer to Chapter 3, *CAN (Controller Area Network) Setup*, for more information on the *CAN Initialization Results* screen, or information on setting up or troubleshooting the CANbus or CAN nodes.

6. The Viper Pro Main screen will display. For a description of the features and information displayed on the Main screen, see Chapter 4, *Navigating the Viper Pro Interface*.

## Touch Screen Calibration Wizard

When the operator touches an area of the screen, the Viper Pro displays an arrow in the area where the selection has been made. If this arrow does not appear in the correct location, the touch screen may require recalibration.

There are two ways to access the Touch Screen Calibration Wizard:

- Press the power button while the start up prompt is displayed.
- Select the **Calibrate Screen** option at the bottom of the Program Selection Menu screen.

### To complete the Touch Screen Calibration Wizard:

1. Touch and hold in the center of the first of four calibration points.

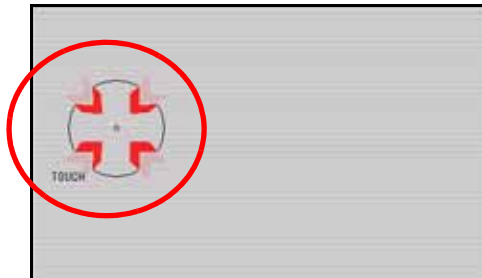

2. When prompted, release the point. The next calibration point will be displayed.
3. Touch and hold the center of each remaining calibration point as they are displayed.
4. Once all points have been calibrated, touch in various areas of the screen to verify that the arrow appears in the correct location.



**Note:** This screen will only be displayed for 1 minute. A count down of time remaining is displayed on the **Cancel** button. If the calibration is not accepted before 1 minute lapses, the calibration will be discarded and Viper Pro will continue to start up with the previous touch screen calibration.

5. Touch the **Accept** button to apply the recalibration and continue the Viper Pro start up sequence. Touching the **Cancel** button discards the recalibration and the Viper Pro will start up with the previous touch screen calibration.



## Registering Your Viper Pro System

The Viper Pro must be registered if an optional feature activation key such as the Multi-Product VRA (P/N 077-0171-152) or Weather Station (P/N 077-0180-030) will be activated. Activation keys are specific to each Viper Pro console. Once activated, a purchased key may not be transferred to a different Viper Pro console.

### Viper Pro Features

The following features are available for the Viper Pro system:

- Multi-Product VRA
- Weather Module

#### Multi-Product VRA

This feature is not required for logging data from a Raven multi-product SCS Console or for “straight rating” multiple products on a Raven CANbus system.

The Multi-Product VRA feature is only required for automatic variable rate control of more than one product on the Viper Pro console. This feature allows the Viper Pro to automatically control product rates in reference to a prescription map or maps.

#### Weather Module

The Viper Pro is capable of reading information from an external weather station and recording this information into the Rbin file and Rbin report. See Appendix L, *Weather Station*, or contact your local Raven dealer for more information.

### To register your Viper Pro:

1. On the main screen, touch the **Menu** button.

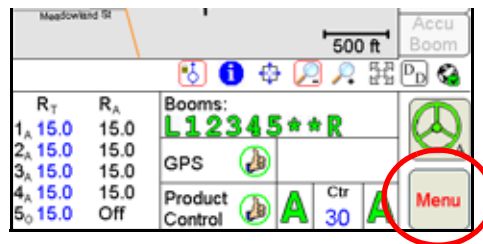

Select **Setup** then **Reg. Keys** to display the Validation Data screen.

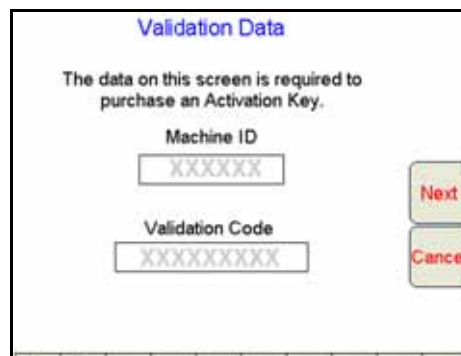

2. Write down the **Machine ID** and **Validation Code** from your Viper Pro console on the Registration Code sheet; an example is shown below.

FIGURE 4. Machine ID and Validation Code

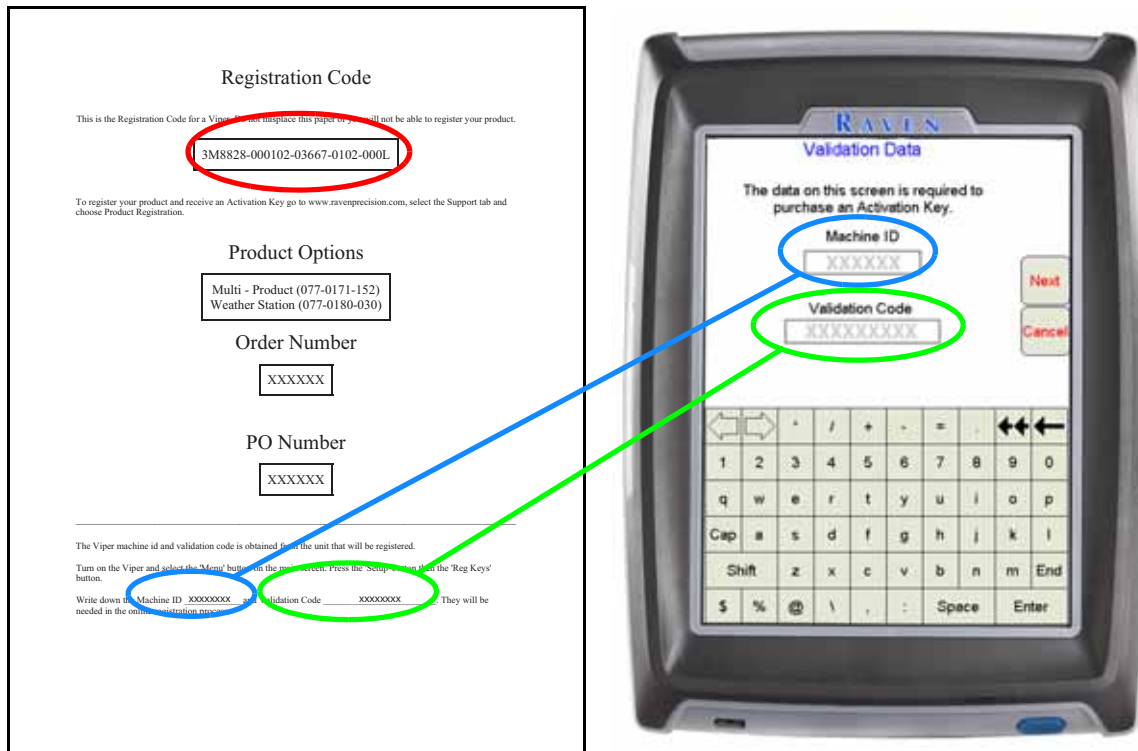

Please note that your Registration Code appears on this sheet as well. You will need this number for future use.

**Note:** The above values are for example purposes only. If you did not purchase any additional Viper features (such as Multi-Product VRA or Weather Module), you will not receive the Registration Code sheet. You should still write down the Machine ID and Validation Code from your Viper system on a blank piece of paper for future use.

3. Press the **Next** button. The Key 1 screen displays. This is the screen on which the Activation Key Code will be entered. Do not navigate away from this screen.

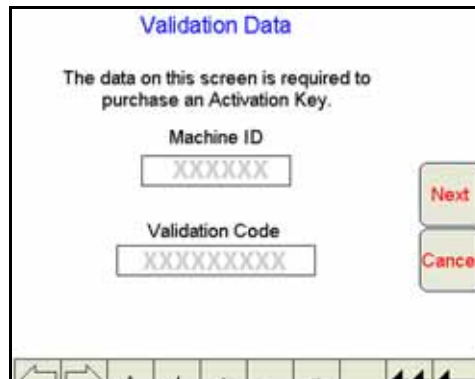

4. On your home or office computer, go to the Raven Precision web site at [www.ravenprecision.com/us/Support/productRegistration.jsp](http://www.ravenprecision.com/us/Support/productRegistration.jsp)

and click the link to register Viper products.

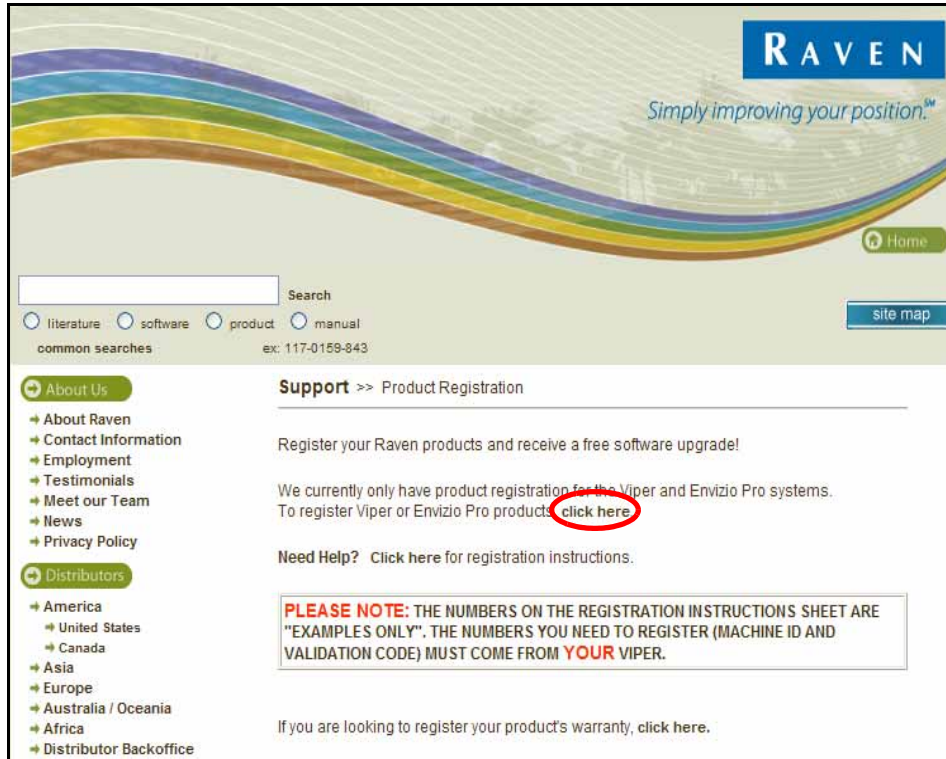

5. Fill in the requested information and then click **Submit**.

The screenshot shows the Raven Product Registration form. The form is titled "Product Registration" and includes the following fields: First Name, Last Name, Company, Address 1, Address 2, City, State/Prov/Terr, Zip/Postal Code, Country (with a dropdown menu), Telephone, E-mail Address, and Select Product (with a dropdown menu). A red circle highlights the entire form area, and a red oval highlights the "Submit" button at the bottom right.

6. The Registration Code screen displays.

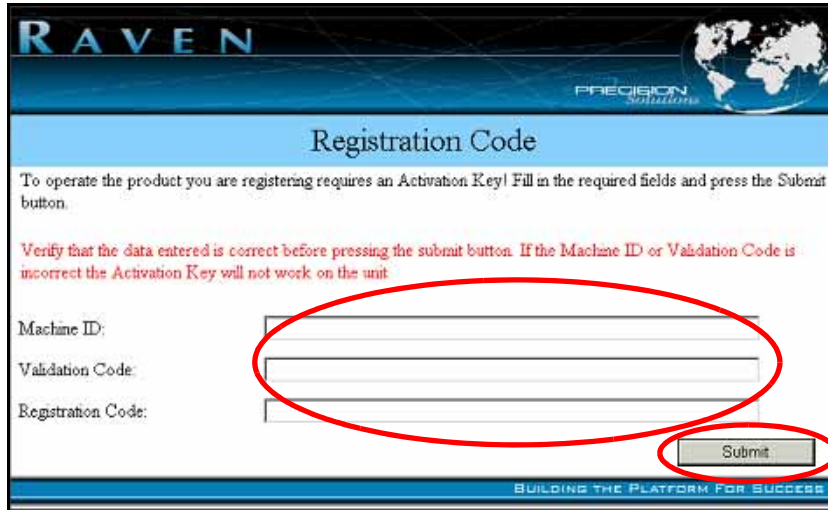

7. Fill in the Machine ID, Validation Code, and Registration Code from the Registration Code sheet. click the **Submit** button.

8. If the registration was processed successfully, the 'Registration Processed' screen will display.



9. Locate the product **Activation Key**.

**Note:** *Print this page and save it for your records.*

10. Back on the 'Key 1' screen on the Viper Pro console, use the on-screen keyboard to enter the Activation Key received from the Raven Precision web site (see step 8).



**Note:** If the Viper Pro has been registered previously, touch the Menu button on the main screen and select **Setup**, then **Reg. Keys** and **Next** to display the 'Key 1' screen to enter an Activation Key.

11. Press **OK**. The Activation Key is saved to the Viper system and the appropriate activation keys are validated.

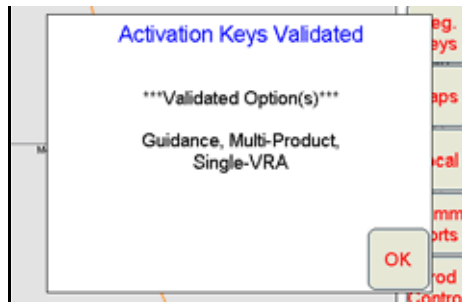



---

## CHAPTER

# 3

# *CAN (Controller Area Network) Setup*

---

---

## *Overview of a Raven CANbus System*

A Controller Area Network, or CAN, is a high-integrity serial data communications bus that operates at a data rate of 250 kilobits per second for real-time control applications and uses special CAN cables and terminators for operation. The CAN protocol has excellent error detection and confinement capabilities, making it very suitable and reliable for agricultural applications.

CAN systems allow products to be added to a control system at any time. Five product control nodes can be connected to the Viper Pro control system for any combination of liquid, granular, chemical injection, or spinner control applications.

The diagrams in this chapter show different hardware configurations for use with the Viper Pro system. Some diagrams show optional features which may not apply to each system. These features and components are not required for CAN operation and optional features and cables may be ignored during a basic installation.

---

## *Raven CAN System Installation*

The following sections contain instructions for proper installation of the Raven CANbus system.



### **NOTICE**

Be sure to read all safety instructions and follow all installation procedures to ensure proper installation of the CANbus system.



## Best Installation Practices

The information below illustrates proper methods for wiring a CANbus system. The diagrams provided later in this chapter are a good reference for both OEM and aftermarket installations. The main points are summarized below.

1. Always use sealed connectors with dielectric grease. Unsealed, crimped connections (i.e. butt connectors) should be avoided.
2. Isolate the power and ground sources for the console and node logic power on separate leads to the vehicle battery or another source of clean power.
3. Use dedicated bus bars to connect the console and all nodes to the same source for both power and ground.

**Note:** *Connecting the GPS receiver (low current) to the CANbus bars allow engine shutdown without losing GPS.*

4. Provide relays to switch power to the CAN nodes on and off to avoid draining the battery. Raven recommends connecting the console directly to the vehicle's battery and using the console 'orange' wire to switch a relay to provide power to the CAN nodes. This makes the console the master power switch and allows engine shutdown without turning off the console.

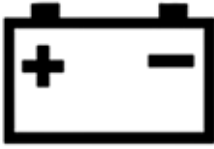
	<p style="text-align: center;"><b>CAUTION</b></p> <p>Viper Pro consoles with hardware revision A or higher should be connected directly to the vehicle battery.</p> <p>Consoles with no revision ("Rev -" or empty rev box on Viper Pro console tag) should be connected to a clean, controlled power source.</p>
--	---

Following these recommendations will result in the most robust system possible while greatly reducing CAN communication problems.

### CAN Terminators

Two CAN terminators (P/N 063-0172-369) are required to provide optimal signal integrity through the CANbus. These terminators should be installed at each end of the CANbus. A CAN power adapter tee cable (P/N 115-0171-368) should be placed toward the front of the bus with one end terminated. CAN power, obtained from a switched power source, runs throughout the bus to act as a shield.



---

## Wiring Power to a CANbus System

Wiring power to the Viper Pro console and the CAN nodes is especially important for proper operation of the system. Many issues in CAN systems can be traced to improper wiring of power and ground. Review the following items and refer to Figure 1, "CAN Node Wiring Diagram," on the next page to properly connect your Viper Pro and CAN system to power and ground.

- See the *Power Connection* section on page 10 for instructions on connecting the Viper Pro to a clean power source.

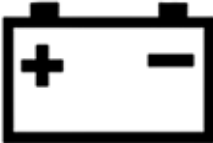
	<p style="text-align: center;"><b>CAUTION</b></p> <p>Be sure to follow the instructions for connecting the power leads to the battery carefully. Reversing the power leads may cause damage to the Viper Pro.</p>
---	---

- All ground wires must be connected directly to the battery ground, not to chassis ground.
- The CAN logic power must be wired to a clean power bus that is connected to a clean power bus relay.
- Use the orange wire from the Viper Pro main interface cable (P/N 115-0171-746) to control the clean power bus relay.
- The CAN high current power must be wired to a high current power bus connected to a high current power relay.
- The high current power relay should be controlled by the vehicle ignition switch.





## CAN Node Off-line Errors

The most likely causes for losing CAN communication between the console and any one of the nodes are:

1. Corroded and/or open connections in the circuit.
2. Console and/or CAN node logic power and grounds connected to a “dirty” power source (dirty power is defined as any circuit with a variable load that exceeds 1 ampere). This is especially true of circuits loaded by electrical coils.
3. Console and/or nodes connected to different power and/or ground sources. This can result in components operating at different voltage planes.

---

## *Adding Nodes to the CAN System*

You can add up to five products to the Viper Pro CAN system plus AccuBoom, and/or AutoBoom. The minimum nodes Viper Pro requires for CAN product control are the boom/speed node, or combo node, and one product node.

**Note:** *The Viper Pro console can be connected to a serial console without needing a boom/speed or product node. An AccuBoom or AutoBoom node may still be connected to the Viper Pro.*

1. Remove the CAN passive terminator (P/N 063-0172-369) from the end of the CANbus.
2. Using a tee expansion cable, tie into the CANbus. You can use one of the following cables:

Part Description	Raven Part Number
Tee Expansion Cable - 6 ft.	115-0171-326
Tee Expansion Cable - 12 ft.	115-0171-362
Tee Expansion Cable - 18 ft.	115-0171-690
Tee Expansion Cable - 24 ft.	115-0171-363
Tee Expansion Cable - 6 inches	115-0171-364

3. Connect the boom interface cable to the installed Tee cable. Contact your Ravendealer for the correct part number for your application.
4. Connect the boom sense/speed node (P/N 063-0172-272) to the boom interface cable (gray connector to gray connector and black connector to black connector).
5. Add a second tee expansion cable to the end of the CANbus cable.
6. Connect the product node cable to the CANbus cable. Contact your Raven dealer for the correct part number for your application.
7. Connect the product node cable to a source of high current power and logic power. Provide power to the nodes in accordance with the instructions for *Wiring Power to a CANbus System* section on page 23.

**Note:** *Connect the ground directly to the battery terminals and the logic to the clean power bus.*

8. Connect the product node to the product node cable (gray connector to gray connector and black connector to black connector).
9. Replace the CAN passive terminator on the end of the CANbus system.

## Detecting CANbus Nodes

The Viper Pro console must be able to communicate with the CANbus system to make sure product is being applied correctly. Viper Pro should automatically establish communication with the boom/speed node and all product nodes connected to the CANbus.

FIGURE 3. CAN Initialization Results Screen

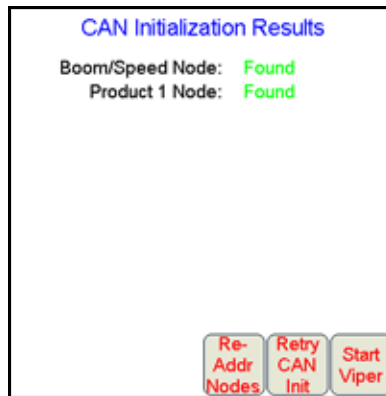

**Note:** If the Viper Pro console establishes communication with a node, it displays as 'Found' on the CAN Initialization Results screen. Nodes not detected during startup will not be displayed on this screen.

If a product node is not found by the Viper Pro console, you will need to determine why Viper cannot communicate with the node. See Chapter 12, *Troubleshooting the Viper Pro System*, for more information about communication failures.

## CAN Initialization Results

1. If you have not done so already, power up your Viper Pro console.
2. The CAN Initialization Results screen displays. If the CAN system found all of your nodes, press **Start Viper**. If not, press **Retry CAN Init**.

**Note:** If the product nodes are not found and this is a new installation, skip to the *Re-Addressing Product Nodes* section on page 28 and follow the instructions for addressing the product nodes.

3. If product nodes which had been 'Found' during previous Viper Pro applications, but are still not displayed after step 2, you will need to troubleshoot the CANbus system to determine why the node is not communicating with the CAN system (i.e. No logic power, ground issues, faulty CAN connector, etc.).

## Selecting a New Controller

If the CAN Initialization Results screen does not appear during the start up sequence, the Viper Pro is not configured as the CAN controller.

### To Configure Viper Pro as the CAN Controller:

1. Touch the **Menu** button on the Viper Pro Main screen.
2. Within the Menu, select **Setup**, then **Prod Control**. The Select Controller screen will be displayed.
3. Use the **Up/Down** arrow keys until '**CAN**' is displayed in the list.

4. Touch the **CAN** option to select it and press **OK**. A Controller Setup message will be displayed.
5. Press **OK**. Viper displays an Exit Program message.
6. Press **Yes**. The Profile screen will be displayed to allow the profile to be saved. Using the on-screen keyboard, type a new profile name and touch **OK**.
7. Press **OK** again and select **Viper Pro**.
8. Press **OK**. The Viper Pro console will restart.
9. When the CAN Initialization Results screen appears and if all of your CAN nodes are 'Found', press **Start Viper**.
10. If the product nodes are still not found, touch the **Retry CAN Init.** button to allow Viper Pro to retry the CANbus detection. If nodes are still not found, the product nodes must be re-addressed. See the following procedure for *Re-Addressing Product Nodes*.

## Re-Addressing Product Nodes

If the Viper Pro cannot detect a CAN product control node (i.e. single product node, dual product node, motor control node, etc.) during the start up sequence, troubleshoot the CANbus and the node, and then re-address the CANbus:

1. Press **Re-Addr Nodes** from the CAN Initialization Results screen.

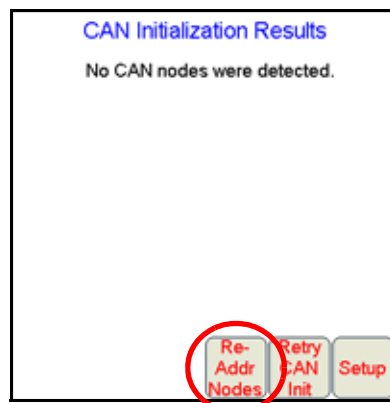

2. The Readdress screen displays.

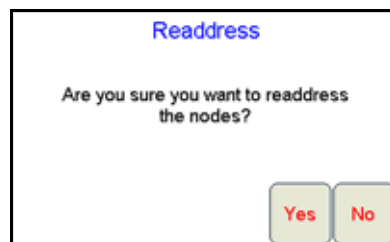

3. Press **Yes**. The Re-Address CAN Nodes screen displays.
4. Cycle the power to the node you want to be controlled as Product 1. To cycle the power:
  - a. Disconnect the logic power from the node
  - b. wait a few seconds
  - c. Reconnect.
5. Press the **Next** button on the Viper Pro to cycle the next product node in the system.
6. Repeat steps step 4 and step 5 until you have re-addressed all product control nodes in the system.
7. Press **Finish**.
8. Press **Start Viper** when all the product nodes in the system display as 'Found'.

## Programming Nodes on the CANbus System

Once communication has been established between the product control nodes and the Viper Pro console, the nodes are ready to be programmed.

**Note:** If the Viper Pro is set up as the CAN controller, the boom sense/speed node, and at least one product control node must be programmed to allow the Viper Pro to control application of a product during a field application.

Many of the CAN nodes may be programmed by selecting the **Product Control Area** on the Viper Pro main screen.

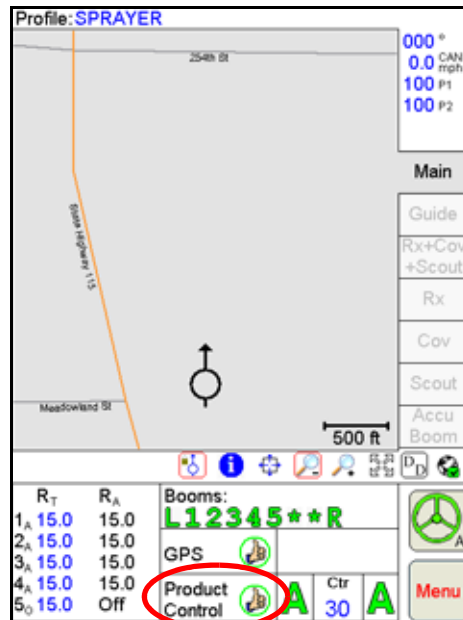

The following information areas display on the CAN Controller Status screen:

- Boom Cals Area
- Miscellaneous Settings Area
- Data Box 1
- Data Box 2
- Pressure Area
- Application Area
- Tally Registers
- Alarms

# Boom Cals

The Boom Cals area displays an overview of the currently configured boom or implement section widths.

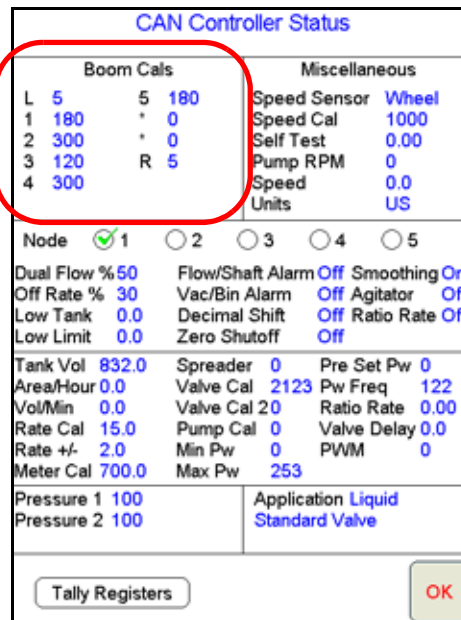

Touch inside the Boom Cals area on the CAN Controller Status Screen to display the Boom Select screen.



The Boom Select screen is used to assign enabled products to the configured boom or implement sections. Place a check mark in the corresponding product column to assign that product to a boom section.



## Miscellaneous Settings Area

The following readings and settings are displayed in the Miscellaneous area:

- Speed Sensor
- Speed Cal
- Self Test
- Fan/Pump RPM (Display only)
- Speed (Display only)
- Units

CAN Controller Status			
Boom Cals		Miscellaneous	
L	5	5	180
1	180	*	0
2	300	*	0
3	120	R	5
4	300		
Speed Sensor		Wheel	
Speed Cal		1000	
Self Test		0.00	
Pump RPM		0	
Speed		0.0	
Units		US	
Node <input checked="" type="radio"/> 1 <input type="radio"/> 2 <input type="radio"/> 3 <input type="radio"/> 4 <input type="radio"/> 5			
Dual Flow %	50	Flow/Shaft Alarm	Off Smoothing On
Off Rate %	30	Vac/Bin Alarm	Off Agitator Off
Low Tank	0.0	Decimal Shift	Off Ratio Rate Off
Low Limit	0.0	Zero Shutoff	Off
Tank Vol	832.0	Spreader	0 Pre Set Pw 0
Area/Hour	0.0	Valve Cal	2123 Pw Freq 122
Vol/Min	0.0	Valve Cal	20 Ratio Rate 0.00
Rate Cal	15.0	Pump Cal	0 Valve Delay 0.0
Rate +/-	2.0	Min Pw	0 PWM 0
Meter Cal	700.0	Max Pw	253
Pressure 1	100	Application Liquid	
Pressure 2	100	Standard Valve	
Tally Registers		OK	

The Miscellaneous area on the CAN Controller Status screen displays an overview of the selections and settings accessible by touching within the Miscellaneous area.

### Fan/Pump RPM

The Fan or Pump RPM is a display only. This read out displays the Fan RPM if a fan sensor is being used with a granular application or a Pump RPM if a pump sensor is equipped for a liquid application.

### Speed Display

Speed is a display only. The Speed read out displays the current ground speed of the vehicle or the entered Self Test Speed. See the *Using the Calibration Assistance:* section on page 33 for information on entering and using a Self Test Speed.

## Miscellaneous Settings Screen

The other values and settings displayed in the Miscellaneous area on the CAN Controller Status screen may be modified by touching within the Miscellaneous Area. The Miscellaneous Settings screen is displayed.

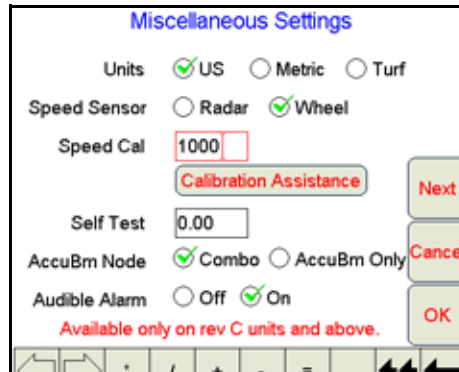

### Units

The Units selection allows the operator to select the preferred units for display during product application. Select:

- **US** to apply product in units per acre
- **Metric** to apply product in units per hectare
- **Turf** to apply product in units per 1000 ft.<sup>2</sup>

### Speed Sensor

Set the speed sensor selection for the type of speed sensor connected to the Viper Pro. Use the **Wheel** option if a magnetic type, such as a wheel magnet or drive shaft magnet, system is used with the Viper Pro. Set the speed sensor setting to the **Radar** option if a radar or GPS unit is sending speed information to the Viper Pro.

### Speed Cal

The Viper Pro must be calibrated for the type of speed sensor connected to the system. The following speed calcs for initial system setup:

Sensor Type	US	Metric
Raven Radar	598	152
Raven Invicta or Phoenix DGPS Receiver	785	199
Wheel Magnets	1000	254
Speedometer Drive Speed Sensor	612	155

**Note:** *These values are good starting points and generally yield adequate results, however, the speed cal should be refined for your specific vehicle and speed sense system. See Appendix E, Calculating Speed Calibration, for instructions on refining the speed cal value.*

*If another source will be used to detect vehicle speed, touch the **Calibration Assistance** button and follow the on-screen instructions. The procedure in Appendix E, Calculating Speed Calibration, should also be performed to refine or verify the initial value.*

**Using the Calibration Assistance:**

1. Touch within the **Product Control** area on the main screen.
2. Touch within the **Miscellaneous Settings** area on the CAN Controller Status screen. The Miscellaneous Settings screen will display.

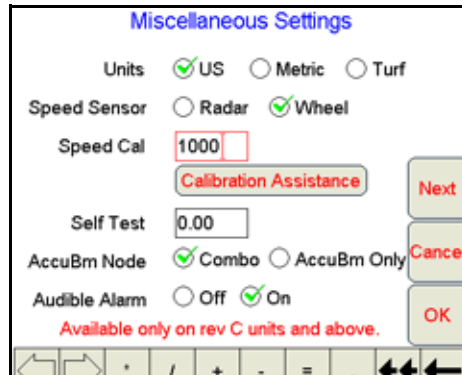

3. Press the **Calibration Assistance** button on the Miscellaneous Settings screen. The Speed Calibration screen will appear.

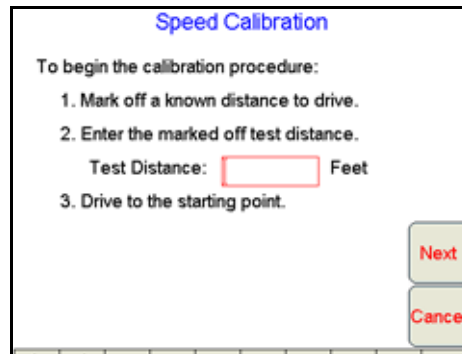

4. Mark off the physical distance to be driven for the test.
5. Enter a measured test distance, in feet, in the **Test Distance** box.

**Note:** If Metric is selected for Units of Measure, the test distance will be in meters.

A distance of at least 500 feet [152 meters] should be entered. A shorter distance may give less accurate results.

6. Press **Next**.
7. Begin driving the machine toward the test distance starting point at normal speed. When the beginning of the test distance is reached, touch the **Begin Cal Run** button. **\*\*Calibrating\*\*** will begin flashing on-screen.

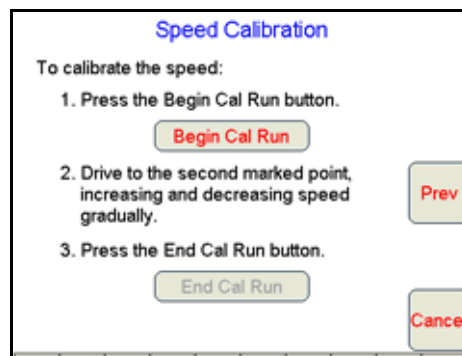

8. Drive the test distance.

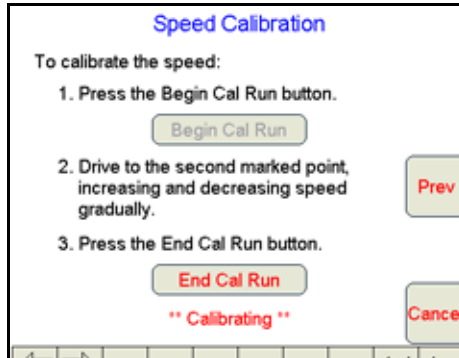

9. At the end of the measured test distance, press the **End Cal Run** button. The new speed cal value will be calculated automatically.

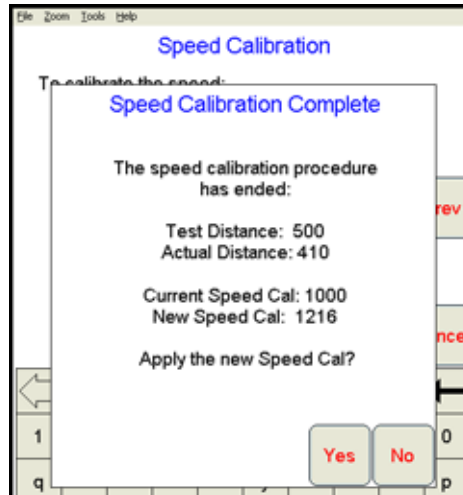

10. Press **Yes** and the new speed cal will be applied.

**Note:** Press **No** to discard the calculated speed cal and continue using the existing value.

11. To verify the calculated value:

- a. Press **OK** on the Miscellaneous Settings screen to return to the CAN Controller Status screen.
- b. Touch the **Tally Registers** button at the bottom of the screen.



- c. Touch the **Reset** button next to the Distance display on the Tally Registers screen.

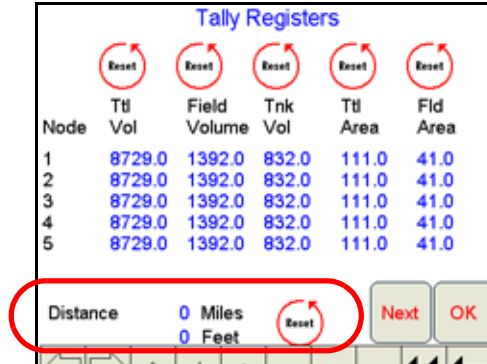

- d. Re-run the same test distance driven during the **Calibration Assistance** procedure. If the Distance display on the Tally Registers screen matches the measured test distance, the calculated speed cal is correct. If the Distance display does not match, see *Appendix E, Calculating Speed Calibration*, for additional speed cal calibration procedures.

### AccuBoom™ Node

If an optional AccuBoom control node (P/N 063-0172-316), AccuBoom combo node (P/N 063-0172-714), or Raven SwitchPro is connected to the CANbus, the AccuBoom node option will be displayed. Select the type of node on your machine. If no AccuBoom node is installed, ensure “Combo” is selected.

### Audible Alarms

Viper Pro can sound a five second alarm tone whenever a CAN alert condition is encountered (i.e. low tank or bin, zero speed, etc. Audible Alarms are enabled by default.

### Node Version Information

Pressing the **Next** button on the Miscellaneous Settings screen will display the Node Version Information screen. The Node Version Information screen displays the software version, software revision, and program number of each node currently detected by the Viper Pro CANbus.

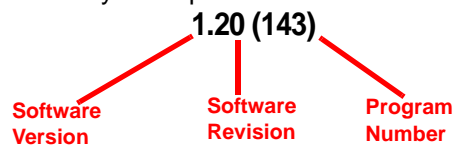

### To Access the Node Version Information screen from the Main screen:

1. Touch in the **Product Control** area on the main screen.
2. Touch within the **Miscellaneous** area on the CAN Controller Status screen.

3. Touch the **Next** button. The Node Version Information screen displays.

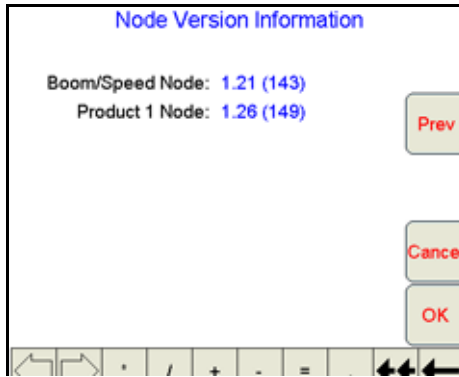

4. Press **OK** when finished viewing or **Prev** to go back to the Miscellaneous Settings screen.

## Data Box 1

The information displayed in Data Box 1 is an overview of the following settings for the selected product control node.

• Dual Flow %	• Flow/Shaft Alarm	• Display Smoothing
• Off Rate %	• Vacuum/Bin Alarm	• Agitator
• Low Tank	• Decimal Shift	• Ratio Rate
• Low Limit	• Zero Speed Shutoff	

The selected product control node appears with a check mark in the corresponding radio button. To switch the selected node, touch the radio button for the desired product node.

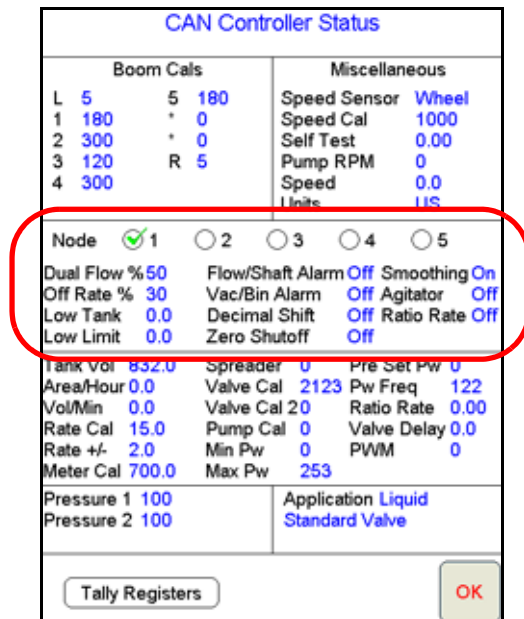

Touch within Data Box 1 to view the first Settings screen for the selected node.

## Node Settings Screen (Page 1)

Touch within Data Box 1 to view the first Settings screen for the selected node.

**Note:** Press the **Next** button to access additional options and settings found on the selected Node Settings screen.

### Dual Flow %

The Dual Flow Percent setting will be used with injection or Granular 3 applications.

In injection applications, the Dual Flow % value sets the tolerance between the flow switch monitor and the flow rate sensor. The flow switch alarm activates when out of tolerance conditions have been met for at least five seconds.

In Granular 3 applications, the Dual Flow % sets the tolerance between the dual encoder readings before the 'Dual Flow' alarm is enabled. The flow switch alarm activates when out of tolerance conditions have been met for at least five seconds.

### Off Rate %

Use the Off Rate % to set the allowable difference between the actual and target application rates. If a non-zero value is entered for this setting and the Off Rate % is exceeded for longer than five seconds, the Viper Pro will display an off rate alarm.

**Note:** If the Audible Alarms feature is enabled, the Viper Pro will sound an alert tone if the Off Rate Alarm is activated. See the Audible Alarms section on page 35 for more information on Audible Alarms.

Enter a value of zero to disable the Off Rate % and Off Rate Alarm.

### Low Limit

Set the Low Limit alarm to activate when the actual volume per minute rate falls below the target rate. When the volume falls below the low limit rate, the control valve stops closing and the alarm displays. The low limit rate automatically adjusts to the width of active booms. For example, if a low limit value of 4 is entered but only half of the total boom width is on, Viper adjusts the low limit alarm to 2.

### Low Tank

Enter the limit for volume remaining in the tank. When the calculated volume remaining in the tank falls below this setting, the Viper Pro will display an alert. The alarm shuts off either when the booms are turned off or if you enter a new Low Tank value that is equal to or less than the current tank volume. If you enter a value of zero in the field, the Low Tank alarm is disabled.

## Node Settings Screen (Page 2)

Press the **Next** button on the first Node Settings screen to display the next page of available settings and options.

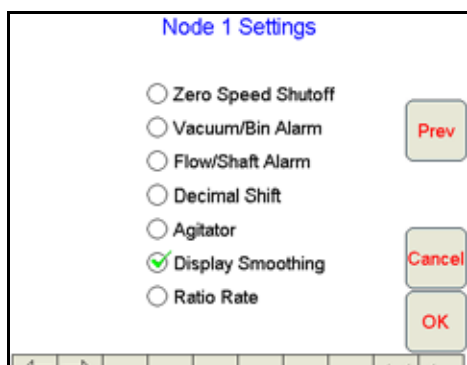

### Zero Speed Shutoff

Use the Zero Speed Shutoff feature in Automatic Control Mode to allow the Viper Pro to turn off product application if the vehicle speed drops below 0.7 MPH. To restart product application, cycle the master switch 'Off' and then 'On'. The Zero Speed Shutoff function will reactivate if the vehicle does not achieve a speed greater than 0.7 MPH and maintain that speed for more than 10 seconds.

### Vacuum/Bin Alarm

The Vacuum/Bin Alarm must be disabled during non-injection liquid applications.

The Vacuum Alarm option may be used when an injection pump is connected to the Viper Pro via a CAN Product Control node capable of controlling an injection product. Enable the Vacuum Alarm to allow Viper Pro to display an alert if the injection pump cannot draw product from the nurse tank.

Use the Bin Alarm during granular applications with an optional bin level sensor installed. With this feature enabled, the Viper Pro will display an alert when the sensor detects the bin level falls below the sensor level.

**Note:** Contact your local Raven dealer for information on injection systems or bin level sensors.

### Flow/Shaft Alarm

You can enable or disable the Flow/Shaft alarm to help control a chemical injection. Disable this alarm when you are not controlling a chemical injection.

### Decimal Shift

Use the Decimal Shift feature to increase the system accuracy for low application rates. In the standard mode, the Viper Pro displays values to one decimal place. With the Decimal Shift feature enabled, values will be displayed to two decimal places.

**Note:** After you have either enabled or disabled the Decimal Shift, verify all calibration values for accuracy. Change settings as necessary.



### Agitator

Enable or disable the vehicle's agitator via the Viper Pro console using this option. Contact your local Raven dealer for required hardware.

### Display Smoothing

With the Display Smoothing feature enabled, the target rate displays as the  $R_A$  (actual rate applied) on the Viper Pro main screen as long as the target rate is within 10% of the actual application rate. The actual rate displays if the vehicle does not reach the deadband within 10 seconds.

With Display Smoothing disabled, the actual application rate displays at all times as the  $R_A$  in the Application Rates area on the Viper Pro main screen.

### Ratio Rate

**Note:** *The Ratio Rate may be enabled or disabled to allow an injected chemical to be applied in ratio to the amount of the carrier. The Ratio Rate should only be enabled with chemical injection applications.*

---

## Data Box 2

The information displayed in Data Box 2 is an overview of the following settings for the selected product control node.

• Tank Volume	• Spreader (Constant)	• Pre Set PW
• Area/Hour (Display only)	• Valve Cal	• PW Freq
• Vol/Min (Display only)	• Valve Cal 2	• Ratio Rate
• Rate Cal	• Fan/Pump Cal	• Valve Delay
• Rate Bump (+/-)	• Min PW	• PWM (Display only)
• Meter Cal/Density	• Max PW	



## Chapter 3

The selected product control node appears with a check mark in the corresponding radio button in Data Box 1. To switch the selected node, touch the radio button for the desired product node.

CAN Controller Status					
Boom Cals			Miscellaneous		
L	5	5	180	Speed Sensor	Wheel
1	180	*	0	Speed Cal	1000
2	300	*	0	Self Test	0.00
3	120	R	5	Pump RPM	0
4	300			Speed	0.0
				Units	US
Node <input checked="" type="radio"/> 1 <input type="radio"/> 2 <input type="radio"/> 3 <input type="radio"/> 4 <input type="radio"/> 5					
Dual Flow %	50	Flow/Shaft Alarm	Off	Smoothing	On
Off Rate %	30	Vac/Bin Alarm	Off	Agitator	Off
Low Tank	0.0	Decimal Shift	Off	Ratio Rate	Off
Low Limit	0.0	Zero Shutoff	Off		
Tank Vol	832.0	Spreader	0	Pre Set Pw	0
Area/Hour	0.0	Valve Cal	2123	Pw Freq	122
Vol/Min	0.0	Valve Cal	20	Ratio Rate	0.00
Rate Cal	15.0	Pump Cal	0	Valve Delay	0.0
Rate +/-	2.0	Min Pw	0	PWM	0
Meter Cal	700.0	Max Pw	253		
Pressure 1	100	Application	Liquid		
Pressure 2	100		Standard Valve		
Tally Registers			OK		

Touch within Data Box 2 to view the first Settings screen for the selected node.

## Data Box 2 Displays

The following sections provide descriptions of the information provided by the display only values in Data Box 2. To access settings for the other values displayed in Data Box 2, touch within this area.

### Area/Hour

Displays the area per hour of product application. This is a display only.

### Vol/Min

Displays the volume per minute of product application. This is a display only.

### PWM

Displays the current duty cycle of the PWM valve.

## Node Settings Screen (Page 1)

Touch within the Data Box 2 to view the first Settings screen for the selected node.

### Tank Volume

Enter the estimated volume of product in the tank. This value must be reset each time the tank is refilled. The Low Tank Alarm feature is based upon the value entered in this field.

Review the *Low Tank* section on page 37 for information about setting the Low Tank Alarm. See the *Tally Registers* section on page 52 for information on resetting the tank volumes to a preset value.

### Rate Cal

Enter the target rate for the product controlled via the selected product node.

### Rate Bump (+/-)

The rate bump setting is the value which the target rate is increased or decreased by selecting the **Up** or **Down** arrows on the Application Control pop-up.

See the *Application Rates* section on page 62 for more information about the Application Rates Area on the main screen and using the rate bump feature during a field application.

### Meter Cal/Density

Depending upon the selected application type, either the meter cal or density setting will be displayed in Data Box 2. See the *Application Area* section on page 50 for information about setting the type of product application.

For liquid product application, the meter cal must be entered to calibrate the Viper Pro to the specific flow meter used to measure product application. The meter cal value is typically found on the flow meter.

For granular products, enter the product density or weight of 1 cubic foot of product in the density setting. The density of the product must be entered to calibrate the Viper Pro to the weight of product being applied.

### Spreader

For granular applications, the specific spreader constant for your gate vehicle's setup must be entered in this field.

**Note:** Enter a zero in this field when applying liquid products.

### Simplified Spreader Constant Calibration

The following procedure steps through the Calibration Assistance wizard for the spreader constant.

1. Touch within Data Box 2 on the CAN Controller Status screen. The first Node Settings screen will be displayed.

**Note:** The application type must be set for Gran 1, Gran2, or Gran3 in order for the Spreader Constant Calibration Assistance button to appear. See the Application Area section on page 50 for more information on selecting the application type.

2. Press the **Calibration Assistance** button. The Spreader Calibration prompt displays with the values currently set for the product density and spreader constant.

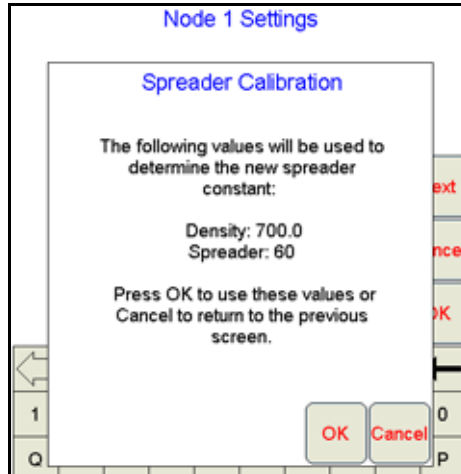

3. Press **OK** to continue the Spreader Calibration wizard.

**Note:** The Viper Pro uses the currently entered product density and spreader constant when performing the Calibration Assistance wizard. Raven recommends setting any known values prior to beginning the Calibration Assistance wizard to ensure accuracy of the Viper Pro system.

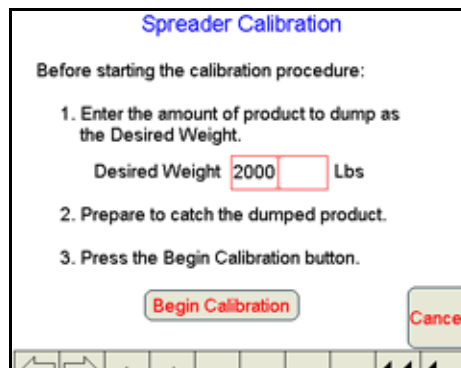

4. Enter the amount of product to dump during the test as the Desired Weight.

**Note:** The weight of product in the bin must be equal to or greater than the value entered as the Desired Weight.

5. Press the **Begin Calibration** button. The second Spreader Calibration screen will be displayed.

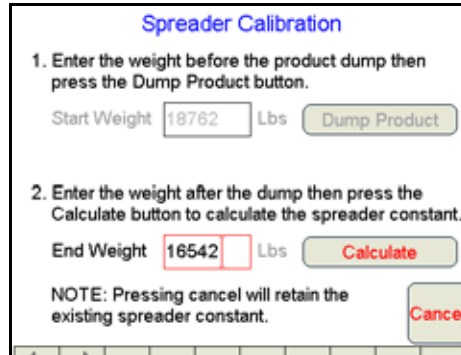

6. Weigh the machine and enter the total weight of the machine as the Start Weight.

**Note:** You can either weigh the machine before and after the dump test or you can weigh the dumped product after the test. If you are going to weigh the amount of product dumped, enter zero in the start weight.

7. Press the **Dump Product** button. The Viper Pro will display the Product Dump Warning prompt.

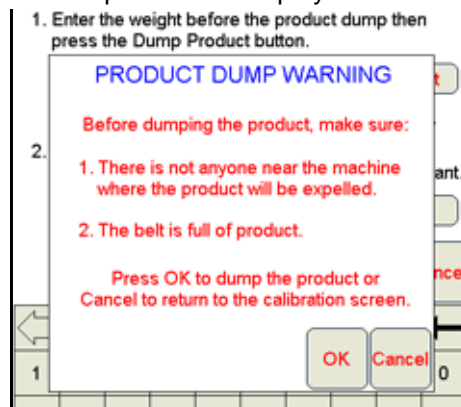

**WARNING**

Product will be expelled when the **OK** button is selected. Be sure to warn or clear anyone in the vicinity of operation of the belt and/or fans during the test. Be sure to disable spinners or fans before starting the test.

**Note:** Make sure the belt is full of product before touching **OK**. If the belt is not full, the test results will be inaccurate.

*If you plan to weigh the dumped product, be sure the weight box or loader is in place and that no product will be spilled on the ground.*

- Press the **OK** button to begin dumping product. The Spreader Constant Calibration screen will appear. The belt will begin to move and the product will begin dumping until the system calculates that the Desired Weight for the test has been dumped.

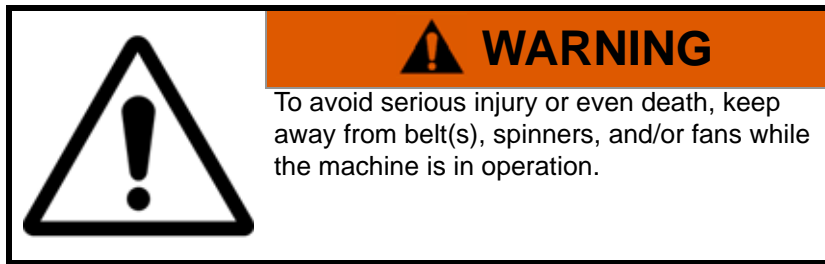

**Note:** A warning will appear if you do not have the spreader switch turned on. Be sure the spreader switch is on to allow product to dump.

- Once the test weight has been dumped, the belt will stop and the Spreader Calibration screen will again appear. Weigh the machine again and enter the machine's End Weight.

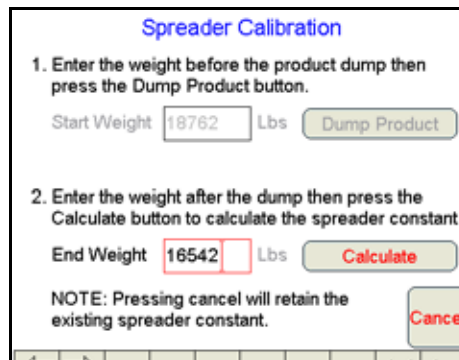

**Note:** If you entered a zero for the start weight, weigh the amount of product dumped and enter the weight of the product as the End Weight.

- Press the **Calculate** button. The Spreader Constant Complete screen will display. This screen will display the old spreader constant and the new spreader constant. Press **Yes** to accept the new spreader constant or **No** to discard the calculated spreader constant.

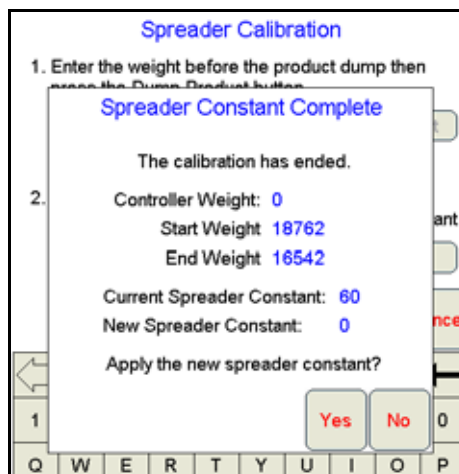

**Note:** Raven recommends performing the Spreader Constant Calibration Assistance wizard again to verify the spreader constant.

## Node Settings Screen (Page 2)

Touch within Data Box 2 and then select the **Next** button on the first Node Settings screen to access the following settings.

The screenshot shows the 'Node 1 Settings' screen with the following fields and values:

Field	Value
Valve Cal	2123
Valve Cal 2	0
Fan Cal	0
Min Pw	0
Max Pw	253

Buttons: Prev, Next, Cancel, OK, PWM Calibration Assistance

### Valve Cal

Enter the appropriate valve cal value for the valve used to turn product application on or off. Raven recommends using the following initial values for the valve cal.

Valve Type	Calibration Number
Standard Valve	2123
Fast or Fast Close Valve (C-F or C-FC)	743
PWM or PWM Close Valve (C-P or C-PC)	43
Motor Control Node (Select Standard Valve)	123

These values are good starting points and will generally yield adequate results, however, the valve cal should be refined for the individual control valves installed on your specific machine.

**Note:** Refer to Appendix F, *Calculating Calibrations for Liquid and Granular Applications*, for more information on calculating your valve calibration.

### Valve Cal 2

This value may be used to fine tune control valve response and help control application rate oscillations when the console is programmed in PWM mode.

**Note:** Valve cal 2 requires product node software version 1.40 or higher for operation.

When a fast close valve is selected, valve cal 2 is utilized to enable a high resolution rate control for lower application rates. Enter a non-zero value for the time, in milliseconds, which the valve will be fully opened before switching into high resolution control. For example, a value of 200 will give the valve a 200 millisecond “burst” at a full 12V to open the fast valve from the closed position before resuming product rate control. A zero value will disable this feature.

### Fan/Pump Cal

The fan cal is used for granular applications only.

For the fan cal, enter the number of counts sensed in one revolution of the fan, if so equipped. For the pump cal, enter the number of counts sensed in one revolution of the pump, if so equipped.

### Min PW

Use the Min PW (Pulse Width) feature to set the minimum desired RPM or hydraulic output (zero point or shutoff point) for a Pulse Width Modulated (PWM) control valve.

### Max PW

Use the Max PW (Pulse Width) feature to set the maximum desired RPM or hydraulic output (zero point or shutoff point) for a Pulse Width Modulated (PWM) control valve.

#### To set the Min and Max Pulse Width:

1. Press the Data Box 2 window on the CAN Controller Status screen. The first Node 1 Settings screen will display.
2. Press **Next**.

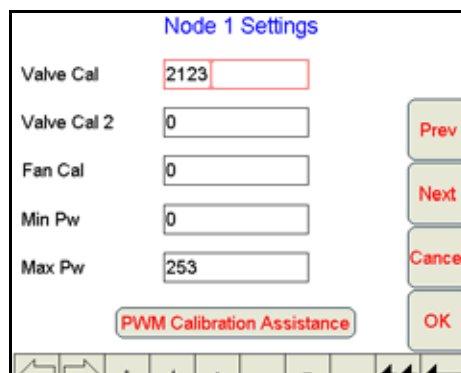

**Note:** The PWM Calibration Assistance button will only appear if either PWM or PWM Close is the selected valve type. See the Application Rates section on page 62 for more information on the valve type selection.

3. Press the **PWM Calibration Assistance** button. The Min PWM Calibration screen will be displayed.

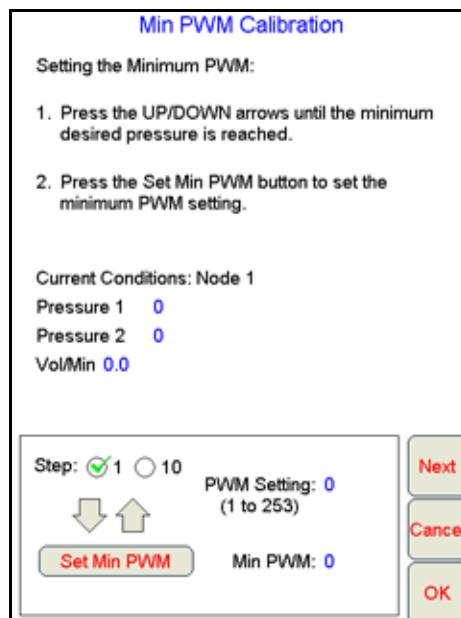

**Note:** The PWM Calibration Assistance wizard screens are displayed with the console in liquid mode.



4. Adjust the Min PW to the minimum value by:
  - a. For liquid systems, use the up or down arrows to adjust the valve until either pressure is observed or the minimum desired pressure is achieved.
  - b. For granular systems, use the up or down arrows to adjust the belt speed until either the belt just begins to move or just stops.

**Note:** You can increase or decrease the step sizes for the up arrow and down arrow buttons by either selecting 1 or 10 for the step size.

*If an electronic pressure transducer is not installed, a manual gauge must be used to calibrate the Min and Max PW.*

5. Press the **Set Min PW** to enter the minimum PW setting.

**Note:** The calculated value for the Min PW setting will be reduced by 10.

6. Press the **Next** button. The Max PWM Calibration screen will display.

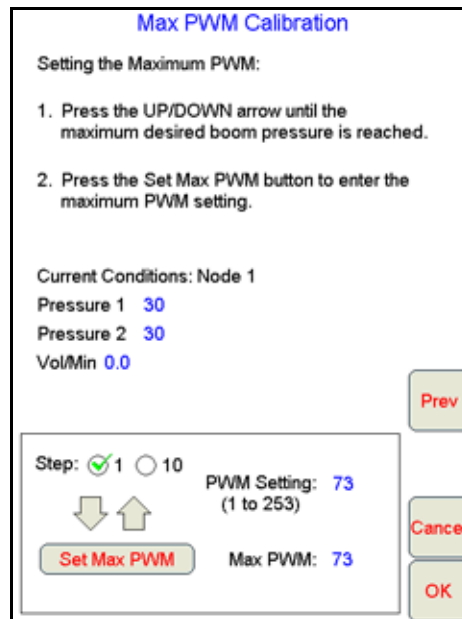

7. Adjust the Max PW to the maximum value by:
  - a. For liquid systems, use the up or down arrows to adjust the valve until the maximum desired pressure is observed on the pressure indicator.
  - b. For granular systems, use the up or down arrows to adjust the belt speed until the maximum desired belt speed is observed.

**Note:** You can increase or decrease the step sizes for the up arrow and down arrow buttons by either selecting 1 or 10 for the step size.

8. Press the **Set Max PW** button to enter the maximum PW settings.
9. Press **OK** to complete the PWM calibration procedure. A screen will display showing the current PWM settings and the new PWM minimum and maximum values.

10. Press **Yes** to use the new calibration settings or **No** to keep the previous settings.

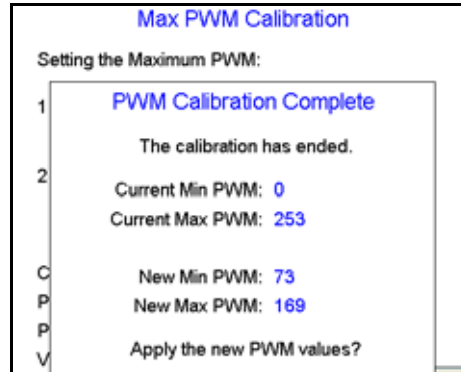

## Node Settings Screen (Page 3)

### Pre Set PW

Use the Pre Set PW setting to set an initial target pulse width value when using a valve that is programmed in PWM Close mode. Enter a value between 1 (slow pulsed width) to 255 (full-scale pulsed width). Viper uses this value to send an initial pulse width to the valve when the booms or nodes are turned on. When a value is entered in this field, the PWM output will not exceed this value when any non-zero booms are off.

When the Pre Set PW value is set to zero, the initial pulse width will be equal to the previous state.

### PW Freq

Enter the coil frequency of the PWM valve in this field. The default value is 122 Hz.

### Ratio Rate

Enter a Ratio Rate value when using a product in an injection system that uses a hand-held spray gun. The product is injected as a ratio to the amount of carrier product applied. For example, if you want 12.0 ounces of product applied with every gallon of carrier product, enter 12.0 in this field. This function works in manual mode only.

**Note:** *This value must be set to zero (0) in a non-chemical injection application.*

### Valve Delay

Set the Valve Delay to include a time delay between when the booms are turned on and when the product nodes start to control the flow rate. Viper activates this delay if the time between turning the boom on and off is less than 30 seconds.

**Note:** *A Value of zero must be entered if a Fast Close or PWM Close valve is used as the control valve or when the Valve Type is programmed as a standard valve with an injection system.*

## Pressure Area

The Viper Pro is capable of monitoring pressure from two separate pressure transducers.

### Dual Pressure

Pressures monitored by the Viper Pro, via electronic pressure transducers, are displayed as P1 (Pressure Transducer 1) and P2 (Pressure Transducer 2) on the Viper Pro.

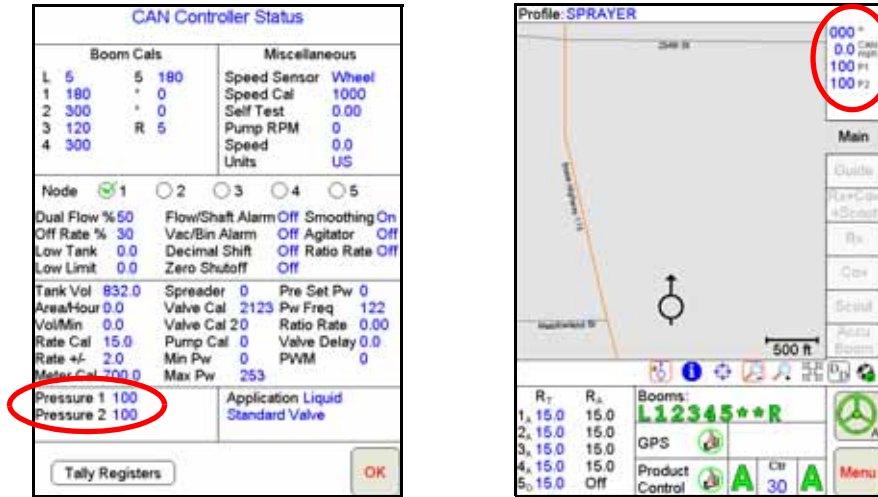

### Viper Pro displays:

- All dashes if the node does not detect a pressure transducer.
- CAL if it detects a pressure transducer but the transducer is not calibrated.

**Note:** Pressure readings are provided as display only and do not affect product control.

## Calibrating the Pressure Transducer Using an Analog Gauge

1. Read the pressure on an analog gauge connected in line with the pressure transducer.
2. Touch the Pressure area in the CAN Controller Status screen.
3. Using the screen keyboard, enter the pressure reading in the **Pressure Sensor** field.
4. Press **OK**. Viper Pro uses the entered value to calibrate to the observed gauge pressure.

## Entering a Setting with no Analog Gauge

1. Make sure that no pressure is applied to the transducer.
2. Enter a value of zero in the **Pressure Sensor** field.
3. Press **OK**.

## Application Area

The Application Area displays the current settings for the application and valve type. The application and valve type may be different for each product node in the Viper Pro CAN Control system.

CAN Controller Status			
Boom Cals		Miscellaneous	
L	5	5	180
1	180	*	0
2	300	*	0
3	120	R	5
4	300		
Speed Sensor	Wheel		
Speed Cal	1000		
Self Test	0.00		
Pump RPM	0		
Speed	0.0		
Units	US		
Node	<input checked="" type="radio"/> 1	<input type="radio"/> 2	<input type="radio"/> 3
		<input type="radio"/> 4	<input type="radio"/> 5
Dual Flow %	50	Flow/Shaft Alarm	Off Smoothing On
Off Rate %	30	Vac/Bin Alarm	Off Agitator Off
Low Tank	0.0	Decimal Shift	Off Ratio Rate Off
Low Limit	0.0	Zero Shutoff	Off
Tank Vol	832.0	Spreader	0 Pre Set Pw 0
Area/Hour	0.0	Valve Cal	2123 Pw Freq 122
Vol/Min	0.0	Valve Cal	20 Ratio Rate 0.00
Rate Cal	15.0	Pump Cal	0 Valve Delay 0.0
Rate +/-	2.0	Min Pw	0 PWM 0
Meter Cal	700.0	Max Pw	253
Pressure 1	100	Application Liquid	
Pressure 2	100	Standard Valve	
Tally Registers		OK	

### To modify settings for the selected node:

1. Touch within the Application Area on the CAN Controller Status screen. After pressing the Application Area, the Node Settings screen displays for the selected product node.

Node 1 Settings	
Valve Type	<input type="radio"/> Standard <input type="radio"/> Fast
	<input type="radio"/> Fast Close <input checked="" type="radio"/> PWM
	<input type="radio"/> PWM Close
Application	<input checked="" type="radio"/> Liquid <input type="radio"/> Gran 1
	<input type="radio"/> Gran 2 <input type="radio"/> Gran 3
	<input type="radio"/> Spinner
	Cancel
	OK

**Note:** The selected product control node appears with a check mark in the corresponding radio button in Data Box 1. To switch the selected node, touch the radio button for the desired product node.

## Valve Type

The following valves are commonly used:

Valve Type	Description
Standard	Select this type when using a standard valve. This is a butterfly-type valve used in liquid applications. The valve stays at the current setting when the control signal is removed. This selection is also used when the product is being controlled by a CAN Motor Control.
Fast	Same as the Standard valve, but can change setting at a higher rate.
Fast Close	Same as the Standard valve, but can change setting at a higher rate.
PWM	This valve uses pulse width modulation to control the speed of a hydraulic motor. Typically used to drive a liquid pump.
PWM Close	PWM valve that closes completely when the master boom switch is in the 'off' position. Typically used to control a hydraulic motor to a spreader apron.

## Application Type

The following table lists a brief description of each application type:

Application Type	Description
Liquid	Liquid Sprayer
Gran 1	Single-belt bed granular system
Gran 2	Split-belt bed granular system
Gran 3	Split-belt bed granular system with dual encoders
Spinner	Spinner control on granular system

## Tally Registers

The Viper Pro may be used to keep track of various totals over the course of a field application, or over the course of a year. To view or reset these totals, touch the **Tally Registers** button at the bottom of the CAN Controller Status screen.

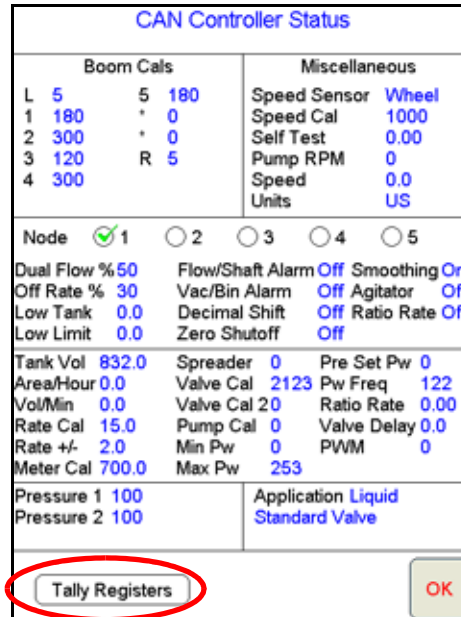

The Tally Registers screen displays the following for each product control node:

- Total Volume (Ttl Vol)
- Field Volume (Fld Vol)
- Tank Volume (Tnk Vol)
- Total Area (Ttl Area)
- Field Area (Fld Area)

This screen also displays the overall distance traveled by the vehicle as calculated by the Viper Pro using the speed sensor and programmed speed cal.

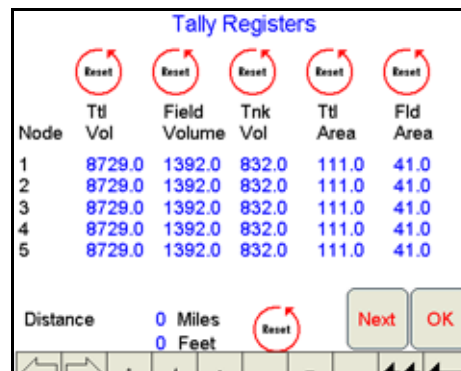

Touch the **Next** button on the Tally Registers screen to view the Odometer screen. Continue pressing the **Next** button to view the Tally Registers for each product control node in the Viper Pro CANbus system.

## Resetting the Tally Registers

Selecting the **Reset** button for any group of totals on the Tally Registers screen will reset the totals for each node at the same time. For example, if you have three product nodes in the system and you press the reset button above the field volume tally, the field volume for all three nodes will be reset to zero.

Pressing reset above the tank volume column will reset all product tank volumes to the tank volume set by the operator.

**Note:** Review the *Data Box 1* section on page 36 or the following *Setting or Resetting Distance and Individual Nodes* section for information on setting the tank volume.

## Setting or Resetting Distance and Individual Nodes

To reset an individual node, or the odometer, press the **Next** button on the Tally Registers screen until the screen for the desired node is displayed. This is helpful when applying product to different fields with different nodes.

1. From the Tally Registers screen, press **Next**. The Odometer screen displays.
2. To set the Viper Pro Odometer:
  - a. Using the on-screen keyboard, enter the desired values for Miles and Feet in the appropriate fields.
  - b. Press **Set**.

3. To reset the Odometer, press the **Reset** button. The Viper Pro odometer is reset to zero.
4. Press **Next**. The Node 1 screen displays.

5. To set tally data for any of the displayed totals:
  - a. Touch the desired field to modify.
  - b. Enter the desired value and press the **Set** button next to the entered value.
6. To reset the data in the fields, press the **Reset** button to the right of the value to reset.
7. Repeat step 5 or step 6 for each node.

8. Press **OK**. Viper Pro saves the changes.

**Note:** *Field volume, field area, and tank volume can be reset while in a job. Total volume and total area can only be reset while a job is not in progress.*

## Alarms

The Viper Pro displays various alarms depending upon the conditions programmed into the console. Specific warning boxes display when the conditions for the alarm are met. In addition to the warning boxes, the Product Control area of the main screen displays a 'Warning' symbol instead of the 'Thumbs Up' symbol.

The CAN Controller Status screen also displays a **Current Alarms** button at the bottom of the screen if an alarm condition is active.

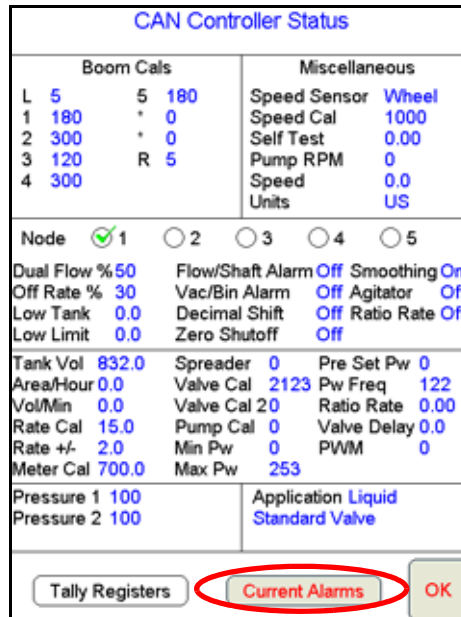

**Note:** *Off Rate and Low Limit alarms will automatically clear once the condition has corrected itself. All other alarms will need to be cleared by pressing the clear alarms button.*

Once you have corrected the condition that caused the alarm, the 'Thumbs Up' symbol displays. To see the current alarms for the system, press the **Current Alarms** button. The Current CAN Node Alarms screen displays:

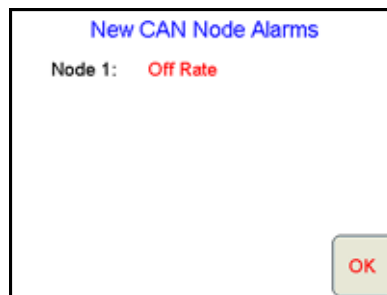

To clear all the current alarms, press the **Clear Alarms** button.



**Note:** *Pressing the Clear Alarms button will clear the current system alarms, but the alarm condition may still be present and may need to be corrected.*

The following table discusses the alarms and the conditions that will set off the alarm.

Alarm	Condition
Off Rate	This alarm activates when the actual application rate differs from the specified percentage rate for more than five seconds. This alarm activates only when the system is in Auto mode. The alarm automatically clears when the target rate and actual rate are within the specified range or when the product mode is switched to either Manual or Off.
Low Limit	This alarm activates when the volume per minute has dropped below the specified limit. This alarm activates only when the system is in Auto Mode. The alarm automatically clears when the volume per minute rises above the specified limit or when the product mode is switched to either Manual or Off.
Low Tank	This alarm activates when the tank volume has dropped below the specified limit. The alarm can be cleared when you either enter a value that is above the low tank value or when you enter a zero in the Low Tank field.
Flow/Shaft	For an injection application, the Flow alarm is active. This alarm activates to indicate a loss of product flow. For a granular application, the Shaft alarm is active. This alarm activates when the shaft sensor in a granular application does not detect shaft rotation. You must troubleshoot the system to determine the cause of the alarm and clear it.
Vac/Bin	For an injection application, the Vac alarm is active. This alarm activates when the vacuum sensor detects a vacuum in the tank. You must troubleshoot the system to determine the cause of the alarm and clear it. For a granular application, the Bin alarm is active. This alarm activates when the bin level sensor detects that the granular level in the bin drops below the sensor.
Dual Flow	This alarm activates for an injection application system when the flow switch monitor and the actual flow readings are out of the specified tolerance. This alarm also activates when Gran 3 is selected as the application type and the rates sensed by the dual encoders are out of the specified tolerance.
Zero Speed	This alarm activates when the speed of the vehicle drops below 0.7 MPH and the Zero Speed Shutoff function is enabled. Cycle the master boom switch to clear the alarm and resume product control.



---

## CHAPTER

# 4

## *Navigating the Viper Pro Interface*

The purpose of this chapter is to familiarize the operator with the Viper Pro interface and display features. The Viper Pro interface allows the operator to quickly view or modify settings and options, retrieve job information, or access job features, all while navigating through the field.

---

### *Main Screen Features*

The Viper Pro's main screen offers an overview for many features and applications of the Viper Pro system. This section is an introduction to the following features displayed on the main screen:

- Profile
- Current Heading
- Pressure
- Speed
- Map Area
- Application Rates
- Booms
- Tabs
- GPS Status Indicator
- SmarTrax Status Indicator
- Product Control Status
- AutoBoom Status
- Display Data
- Wireless Communication Status

## Profile

The name of the currently enabled profile is displayed in the upper left-hand corner of the main screen.

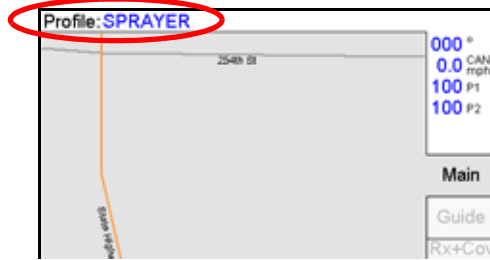

Profiles may be setup for various machines to allow the Viper Pro to be transferred between vehicles quickly and efficiently. The enabled profile name displays only when a job is not in progress.

During a job, the name of the enabled product is displayed in the upper left-hand corner of the main screen. If multiple products are enabled, the Viper Pro displays a product selector and the name of the selected product in the upper left-hand corner.

### Profile Changes

If any of the settings saved within a profile are changed via the Viper Pro user interface, the Viper Pro will request the operator to save the current profile settings before the console is powered down.

To save the new profile, type in a new profile name and touch **OK**.

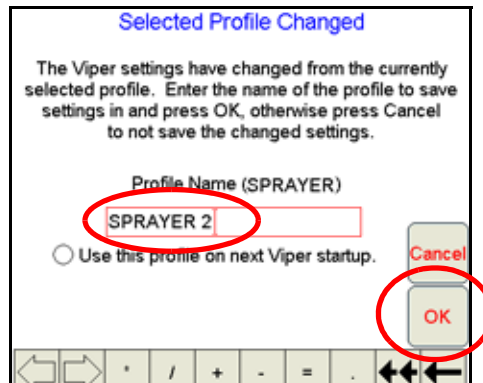

**Note:** Check the 'Use this profile on next Viper startup' button if you would like the Viper Pro system to load and use this profile the next time you turn the power on.

See the Profile Configuration section on page 92 for more information on working with and saving Profiles.

## Current Heading

The current heading of the vehicle, in compass degrees, is displayed in the upper right-hand corner of the screen. A heading of 000° indicates magnetic north.

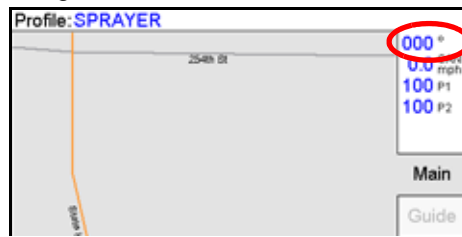

## Speed

The current speed of the vehicle displays in the upper right-hand corner of the screen.

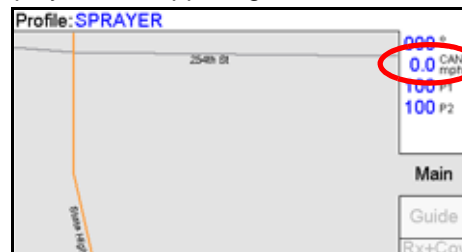

If this section also displays the word “CAN”, then the Viper Pro is connected to a Raven CANbus control system. CAN speed is the speed reported by the CAN control system for product application.

If this section displays the word “GPS”, then Viper Pro is connected to an external Raven console. The reported speed is the GPS speed as determined by a DGPS receiver, such as an Invicta or Phoenix receiver.

**Note:** When connected to an external Raven console, the GPS speed displayed on Viper is for reference purposes only. It may not be the same speed being used by the Raven console for product application. You must make sure that the speed on the external controller is accurate. See Appendix E, Calculating Speed Calibration, for more information on calculating the speed cal.

## Pressure

The Main screen displays pressures monitored via up to two electronic pressure transducers. The monitored P1 (Pressure Transducer 1) and P2 (Pressure Transducer 2) pressure readings are displayed below the vehicle speed display.

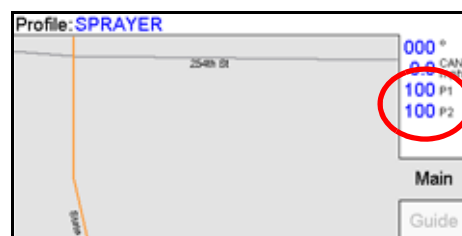

## Map Area

The Map Area displays information associated with the currently active tab.

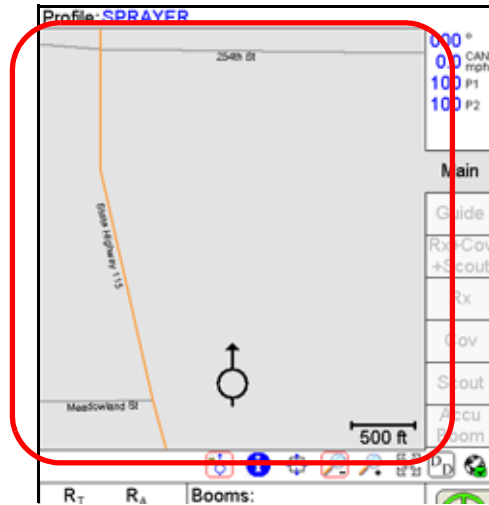

The Map area also displays information regarding the applied products. If more than one product is enabled for the job, the Viper Pro will display application information for the product selected in the top right corner of the screen. This area also displays street, prescription, and coverage map information, as well as guidance and scouting information. The scale of the map currently viewed on-screen is displayed in the lower right corner of the maps area. This scale is only displayed when a job is not in progress on the Viper Pro.





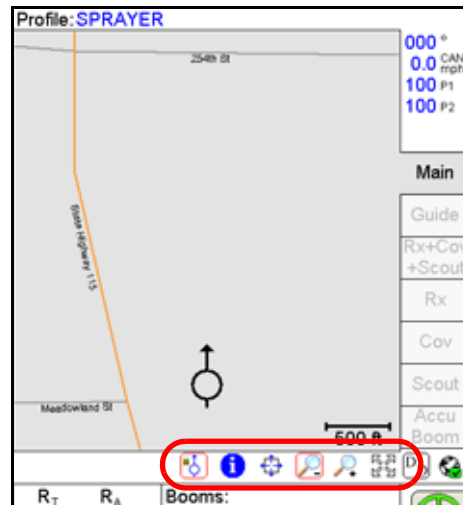

## Screen Tool Icons

Several screen navigation tools are located directly below the Maps area on the Viper Pro main screen.



The following table offers a description of the various tools and, in some cases, how the tools are used. The screen tools available tools may vary slightly depending upon which tab is active.

A red box appears around an active screen tool. To use a tool, simply touch the desired tool icon and touch the area of the Map to perform the selected action.

Icon	Description
	<p>When the CURSOR LOCK tool is active, Viper is in the auto-pan mode. Viper displays the vehicle's current position and will automatically pan the screen as the Course Direction Indicator, or vehicle indicator moves off of the display screen.</p>
	<p>The INFORMATION tool is only available:</p> <ul style="list-style-type: none"> <li>• On the Main tab without a job in progress; or,</li> <li>• On the Scout tab during a job.</li> </ul> <p>Use the INFORMATION tool to view specific information on field features such as area contained within a boundary, field name, etc. To use the INFORMATION tool:</p> <ol style="list-style-type: none"> <li>a. Select the INFORMATION icon. Viper outlines the icon in red.</li> <li>b. Touch the area of the map to display field or scouting information.</li> </ol>
	<p>The PRESCRIPTION tool is only available with the Rx tab selected (if a prescription map had been previously loaded) or the Cov tab. Select the PRESCRIPTION tool to access information on prescription map zones or applied coverage information.</p> <p>To use the PRESCRIPTION tool:</p> <ol style="list-style-type: none"> <li>a. Select the PRESCRIPTION tool icon. Viper outlines the icon in red.</li> <li>b. Touch the area of the map to display prescription information for that area.</li> </ol>
	<p>The PAN icon is used to move screen information up/down or left/right. To use the PAN icon:</p> <ol style="list-style-type: none"> <li>a. Select the PAN tool. Viper outlines the icon in red.</li> <li>b. Touch in the Map area. The point selected will become the center of the map view. Touching near the sides or corners of the screen repeatedly allows the operator to pan to areas outside the immediate field area displayed.</li> </ol>
	<p>The ZOOM OUT icon increases the viewable area, but reduces the map detail. To use the ZOOM OUT icon:</p> <ol style="list-style-type: none"> <li>a. Select the ZOOM OUT tool. Viper outlines the icon in red.</li> <li>b. Touch an area on the map to zoom out from. The Viper Pro adjusts the view. Repeated zooming allows you to continue to scale down a selected area.</li> </ol>
	<p>The ZOOM IN icon increases the map detail, but reduces the viewable area. To use the ZOOM IN tool:</p> <ol style="list-style-type: none"> <li>a. Press the ZOOM IN icon. Viper outlines the icon in red.</li> <li>b. Touch an area on the map to increase detail. The Viper Pro centers and adjusts the view. Repeated touching allows you to continue to magnify the selected area.</li> </ol>
	<p>The ZOOM EXTENTS tool allows you to quickly bring all map information back on the display. It eliminates the need to use the zoom or pan tools to view a complete map.</p> <p>The ZOOM EXTENTS tool also allows you to view items that are not currently near the actual GPS location.</p> <p>For example, if you want to view a prescription map, but you are not near the field for which the map was written, ZOOM EXTENTS will bring the field map into view. You can now access information from the map.</p> <p>To return to the current GPS position, press the CURSOR LOCK icon.</p>



## Tabs

The information displayed in the Map area is dependent upon the selected tab. The following tabs are available while a job is in progress:

- Main
- Guide
- Rx+Cov+Scout
- Rx
- Cov
- Scout
- AccuBoom

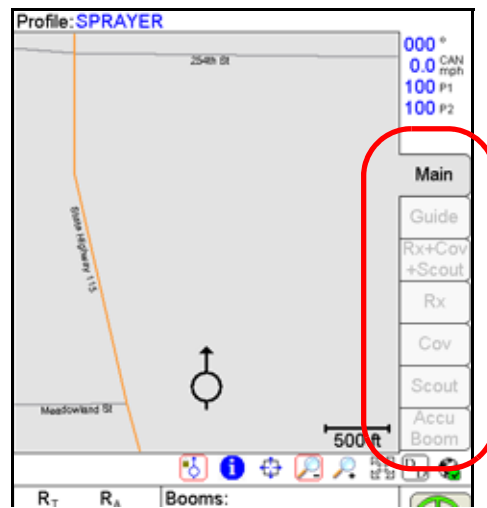

Tabs displayed in gray are currently unavailable for use and the Main tab is the only tab available when no jobs are in progress on the Viper Pro console. Touching available tabs during a job will display and access information for the current field application. The AccuBoom tab is only available if the required hardware has been installed on your machine and the feature has been enabled for the current job. See the *Tabs* section on page 69 for a detailed description of each tab.

## Application Rates

The Application Rate area displays the target rate ( $R_T$ ) and actual rate ( $R_A$ ) in the lower left-hand area of the screen.

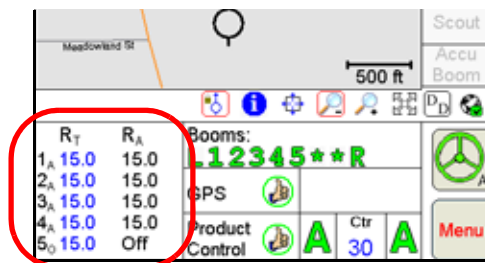



Next to the product node number or indicator, a letter will display. The letters represent the control mode of that product. The following control modes may be displayed next to the node indicator.

Letter	Description
O	The product is off.
M	The product is being applied in the manual mode.
A	The product is being applied in the automatic mode.

If the Viper Pro console is used as the CAN Controller, touching within the Application Rates area displays the Application Control screen. The Application Control screen may be used to make changes to the product control nodes on-the-fly during a field application.

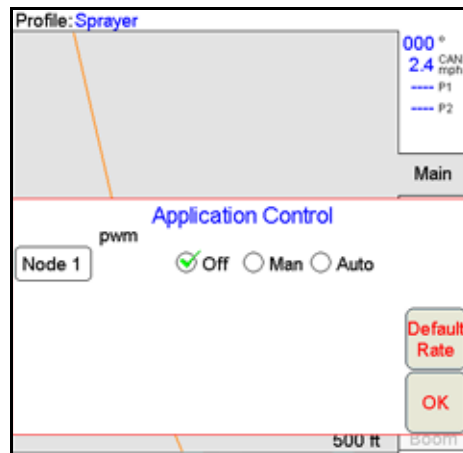

If a prescription map will be used with the Viper Pro console, touch the Default Rate button to display the Rx Map Default Value screen. Set the default value of the target rate for areas without prescription information. The Viper Pro will apply the default rate within any area of a prescription map without a rate. Product control in Zero Rate zones will remain at zero. The default rate only affects areas where prescription rate information has not been entered.

## Booms

The Booms area displays the currently configured boom sections and their display values.

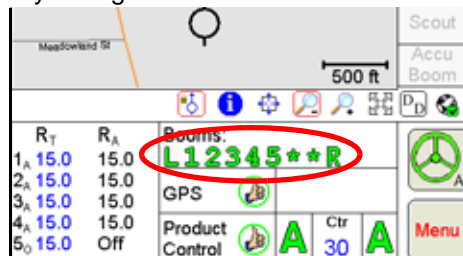



This area also displays the status of each section. If the section display value is green, the section is currently active or on. If the section display is gray, the section is currently disabled or turned off.

Touch within the Booms area accesses the AccuBoom Control Setup screen. If the required hardware has been installed, the Viper Pro can be used to automatically control boom sections based on the coverage map or other scouting information such as a field boundary. See Chapter 7, *Using AccuBoom™*, for a detailed description of the AccuBoom feature.

## System Status Icons

The following icons may be displayed in the GPS Status and Product Control Status areas on the Viper Pro main screen. These icons indicate the current status of these systems and allow the operator to check system functionality at a glance.

Status Symbol	Description
	<p><b>Thumbs Up</b> System is normal and all operating conditions are met.</p>
	<p><b>Caution</b> There is a system alert. The operator should investigate cause of alert condition and correct.</p>
	<p><b>System Error</b> The system is down and requires immediate attention. Errors must be corrected before proceeding with application.</p>

## GPS Status Indicator

The status of DGPS messages being received by the Viper Pro console is displayed in the GPS area on the main screen.

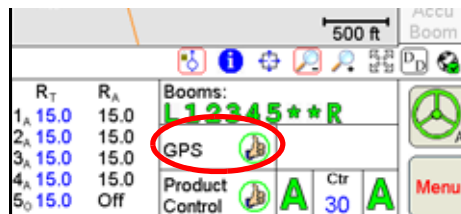

**Note:** This is not necessarily the status of the GPS Receiver or the availability of DGPS reception.

The DGPS Status Indicator displays a green “thumbs-up” if all required messages are being received and updated normally. The indicator changes to a red “X” if GPS information is unavailable or the console is not receiving GPS information from the receiver. A yellow “caution” symbol is displayed if the GPS differential data has not been updated in the last 15 seconds, or if the HDOP (Horizontal Dilution of Precision) exceeds 2.0, or when any other system “cautionary conditions” are met. Touch the GPS Status Indicator to view the GPS Status screen.

## GPS Status Screen

The GPS Status screen displays information from the DGPS receiver and may also display helpful information if the console detects and issues with DGPS reception.



Touch the **Rev Sense** button to display the Reverse Sense screen. Review the on-screen reverse sense description and select the desired mode of operation. With automatic reverse sensing turned off, the Viper Pro will assume forward vehicle motion at all times. Toggle reverse sensing on to allow the Viper Pro to detect when the vehicle is backing up.

With the Rev Sense feature enabled, Viper Pro will prompt the operator for the direction of travel each time the console is powered up.

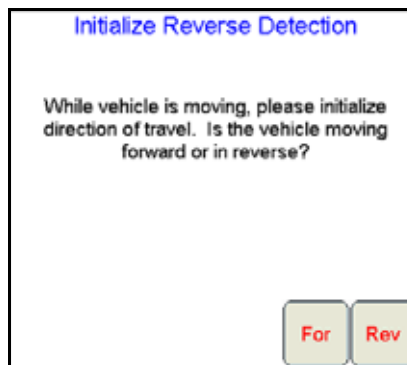

Select the current direction of travel to calibrate the Viper Pro for automatic reverse detection. This feature may be helpful when backing into corners while spraying with AccuBoom enabled. Touch the **Change** button to manually change the heading direction.

Touch the **COG Filter** button to display the Course Over Ground Filter Selection screen. Review the on-screen COG Filter description and select the appropriate filtering level.

Select the **View Data** button to view "raw" GPS data coming from the DGPS receiver into the Viper Pro console via the DGPS port on the Main Interface Cable (P/N 115-0171-746).

Press **OK** to return to the Viper Pro main screen.



## Product Control Status

The Product Control Status of the Raven console or the Raven CAN system is displayed in this area.

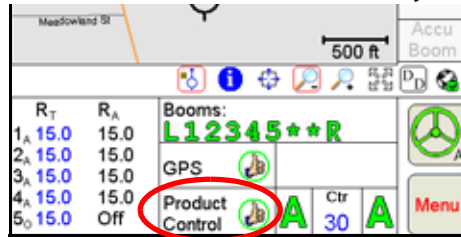

The Status Indicator displays a red 'X' if communication with the Raven control console or CANbus system is not available. A yellow 'caution' symbol is displayed if the Viper Pro detects a problem with the CANbus system such as an alarm condition. The Status Indicator will display a green 'thumbs-up' during normal operation. Touch the Product Control Status or Indicator to view the CAN Controller Status screen and access the Node Setup screens when connected to a Raven CANbus system.

Review Chapter 3, *CAN (Controller Area Network) Setup*, for more information on the Product Control status and using the CAN Controller Status screens on the Viper Pro console.

## AutoBoom™ Status Indicator

The status of the optional AutoBoom feature is displayed in this area.

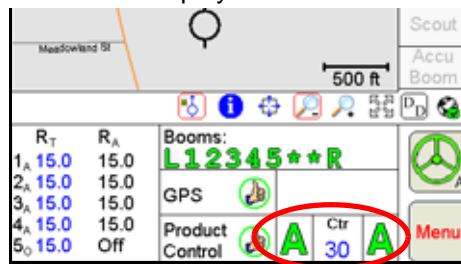

The AutoBoom status is only displayed if a Glide Series AutoBoom™ system has been installed and connected to the Viper Pro console via the Raven CANbus system.

To help the operator manage the AutoBoom system, several status indicators or messages are displayed in this area. For example, the first time that the Viper Pro detects the AutoBoom system, this area displays a "Calibration Required" message. Once the system has been calibrated, this area displays the status of boom height management for each boom. A green 'A' indicates that AutoBoom boom height management is enabled for the left or right boom. The boom height is under operator control if the 'A' in this status display is gray.

Touch within the AutoBoom Status area to display the AutoBoom Control screen for the Glide Series AutoBoom system.

See Chapter 8, *Using AutoBoom™*, for more status display information. For complete calibration and operation procedure, refer to the *AutoBoom Calibration & Operation Manual*.

## Display Data

Press the **Display Data** button to view product information from each product node in the CANbus system on the main screen.

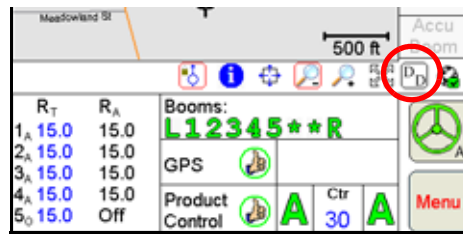

The field volume, field area, tank volume, total volume, total area, and area per hour is displayed within the Display Data screen.

**Note:** The Display Data button does not show up if you are not using a CAN controller.

The data displayed by pressing this button is also available by touching within the Product Control area and selecting the **Tally Registers** button at the bottom of the CAN Controller Status screen.

Press the **Display Data** button to view the first data screen in the lower portion of the Map area. Press within the displayed data area to toggle to the next data screen, including weather information if an optional weather station has been installed. To hide the data display, press the **Display Data** button again.

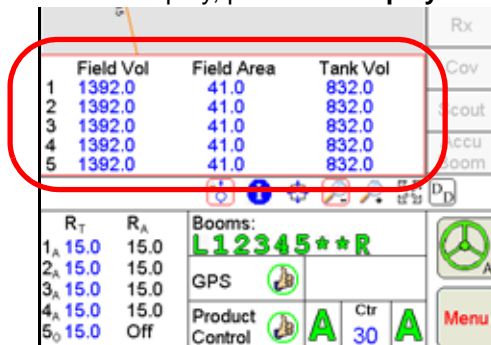

**Note:** See Appendix L, Weather Station, for more information on the optional weather station available for use with the Viper Pro console.



## Wireless Communication Status

The status of wireless communications is displayed on the Viper Pro main screen in the tool bar below the map.

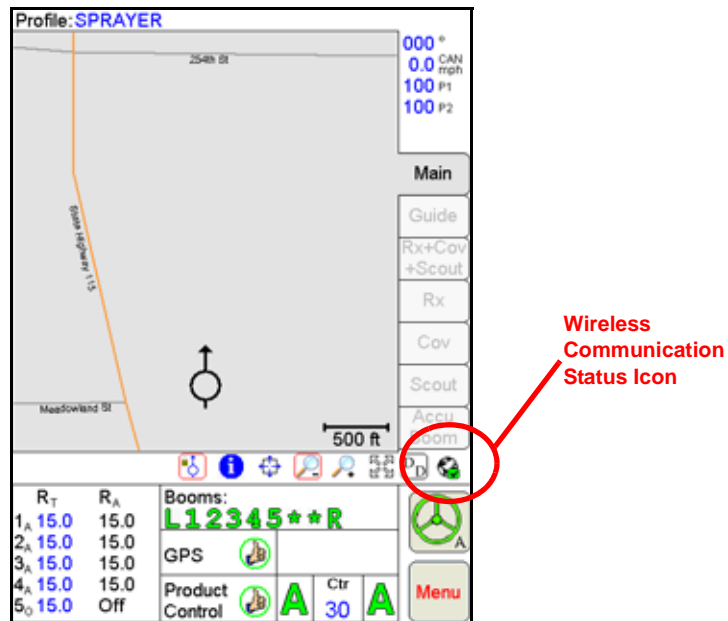

**Note:** For more information on using the wireless communication features with the Viper Pro, see Appendix M, Wireless Communications & Remote Service.

For instructions on installing and setting up your Raven Field Hub, refer to the Field Hub Quick Reference Guide (P/N 016-0171-238) provided with your wireless device.

## SmarTrax™ Status Indicator

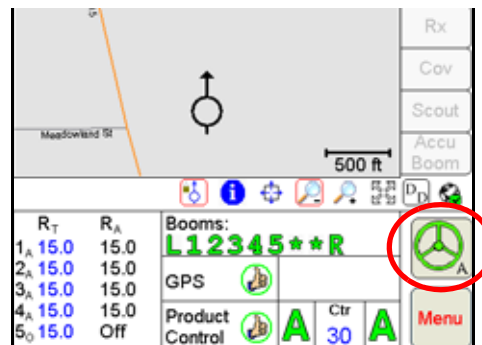

If an optional SmarTrax, SmartSteer, or QuickTrax system has been installed with the Viper Pro, the status of the system will be displayed in this area. If the SmarTrax system is engaged, the status display will show a green steering wheel with the 'A' as shown above. When the SmarTrax system is disengaged, the steering wheel will be grey and no A will appear.

# Tabs

The tabs along the right side of the maps area allow the operator to control the information displayed on-screen during product application or within a field. Tabbed viewing allows the operator to quickly view coverage or scouting maps while navigating through the field and avoid screen clutter.

The following sections offer a description for each of the available tabs.

**Note:** When a job is not currently in progress on the Viper Pro console, the main tab will display all accessible information. The other tabs will be available only when a job is in progress.

Some tabs may not be available unless the optional feature or hardware has been purchased and installed.

## Main Tab

The Main tab displays the following information:

- If a street map for the vehicles current location has been loaded on the Viper Pro console, the Main tab displays the GPS position of the vehicle relative to the displayed map.
- The location of previously saved or created field boundaries is displayed on the Main screen. If a street map is loaded on the Viper Pro console, field boundaries will be shown in relation to the streets.
- The vehicle's current GPS position is displayed as a course direction indicator.
- The scale of the on-screen view is displayed in the lower right corner of the Maps area.

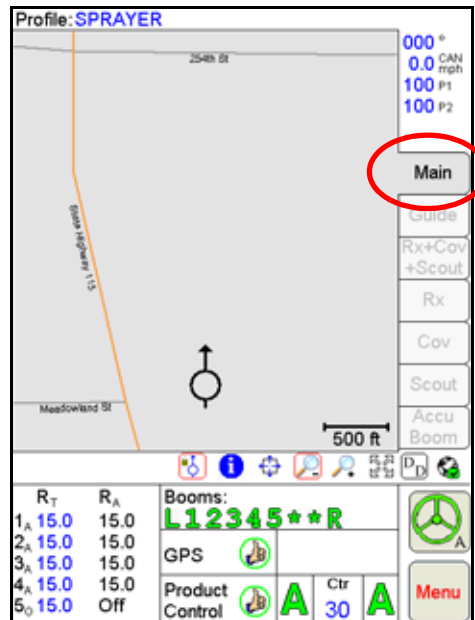

### Field Boundaries

The Main tab displays field boundaries for jobs stored in the Viper Pro's internal memory. These boundaries are shown on the streetmap (as shown on the map below) and can be useful when trying to locate a field in relation to the vehicle location.

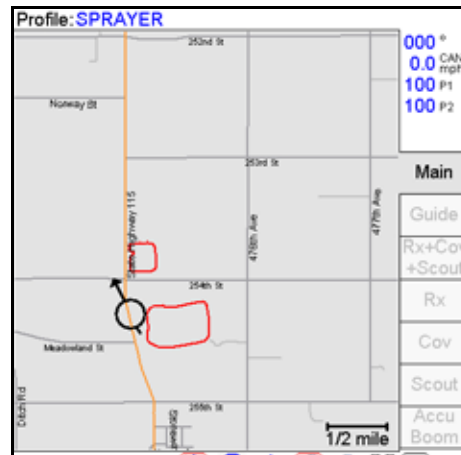

Additional information can be viewed for each boundary by touching the desired boundary. The Viper then displays a boundary preview screen that shows a more detailed field boundary map and additional information on the field.



The following options are available once you have selected the boundary preview:

- Delete This Job -Viper will prompt the operator to save or discard the field boundary
- View This Job - Allows the operator to view a job before opening the file
- Open This Job - Opens the selected job
- Start New Job - Begins a new job with the selected field boundary
- Cancel -Exits the boundary preview screen



## Guide Tab

Swath guidance is a standard feature with the Viper Pro console. During a job, the Guide tab displays guidance information such as the guidance path and swath number for certain guidance paths. The Guide tab is only available if the operator selects the Swath Guidance option during the Start Job procedure. Refer to Chapter 9, *Viper Pro Guidance* for more details on using the Viper Pro Guidance features and available swath patterns.

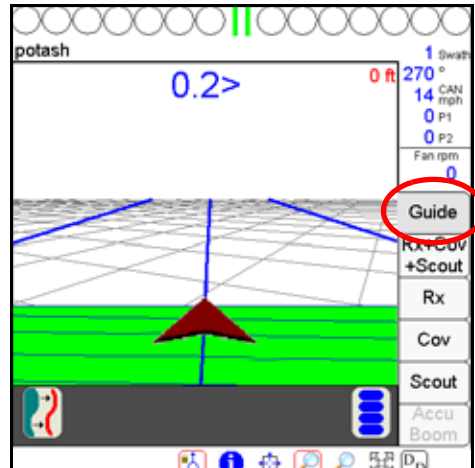

## Rx+Cov+Scout Tab

The Rx+Cov+Scout tab displays scouting and coverage map information on the same screen. Scouting information such as weed or insect infestations and field boundaries or water ways may be pre-recorded and recalled for following jobs. In addition to the coverage map and scouting information, the Rx+Cov+Scout tab may also display prescription map information for the selected field. The coverage map displays over the top of the prescription map as a reference. Scouting information is only displayed on this tab. To edit or create scouting zones, access the Scout tab.

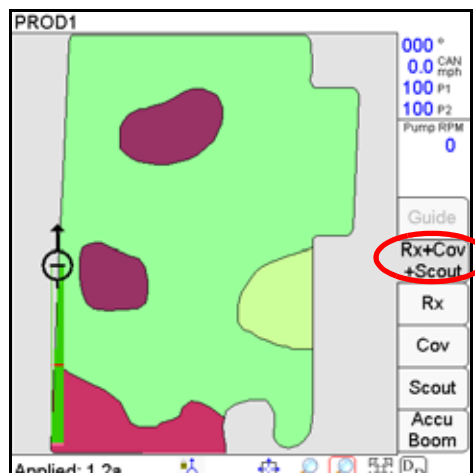

## Rx Tab

The Rx tab is only accessible if a prescription map has been selected for the current job during the Job Setup. The Rx tab displays the target area, or the total area within the prescription map. The following information is also available via the Rx tab and prescription map:

- Latitude
- Longitude
- Product associated with the prescription map
- Prescription application rates

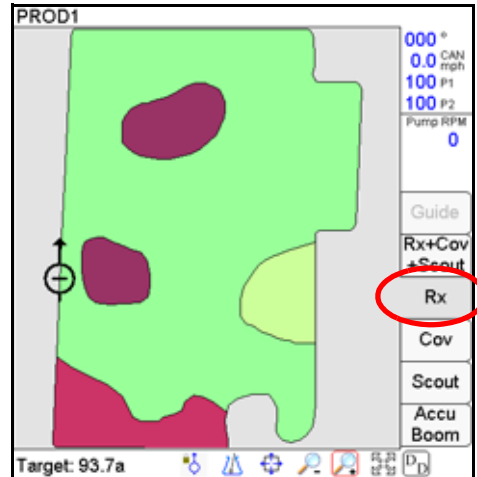

### Accessing Prescription Map Information

To view information contained within a prescription map on the Viper Pro:

1. Load a job with a valid prescription map.
2. Press the **Rx** tab. The Rx screen displays.
3. Press the **Prescription icon** located below the map screen.
4. Touch an area or zone on the map. The Viper Pro displays prescription rate information for the selected map area.

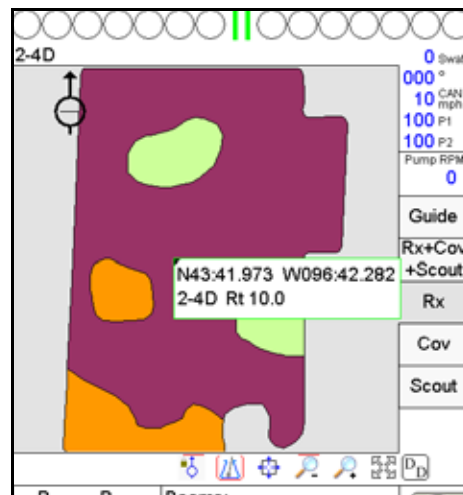

For more information on Rx maps, see the *Prescription (Rx) Maps* section on page 87.

## Cov Tab

The Cov tab displays the coverage map and as applied information as well as the total coverage area for the selected product.

The following information is accessible from the Cov tab and coverage map:

- Latitude
- Longitude
- Products associated with the coverage map

The coverage map displays the configured boom or implement width within the Course Direction Indicator. Section status is also recorded on the coverage map.

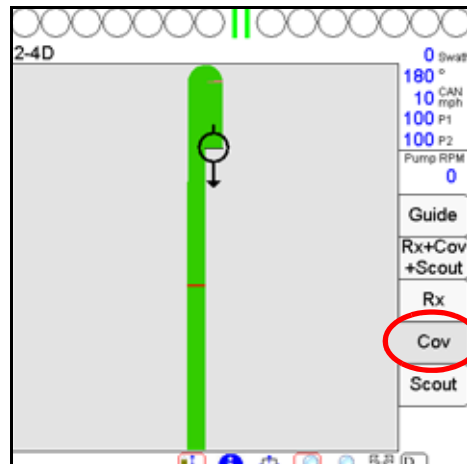

### Accessing Coverage Map Information

To view information regarding the currently displayed coverage map:

1. Load a job with valid coverage information.
2. Press the **Cov** tab. The Cov tab screen displays.
3. Press the **Prescription** icon located below the map screen.
4. Touch a field area or zone on the map. Viper Pro displays product coverage information for the selected area.

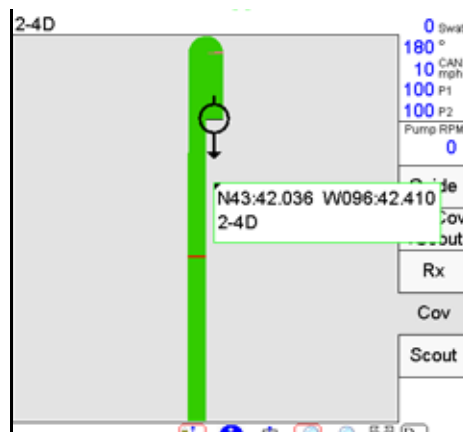

See the *Coverage Maps* section on page 86 for more information about using coverage maps.



# Scout Tab

Field features and other information may be pre-recorded, or scouted, prior to applying product to a field. Scouting information may be used to help reduce the time required during an application or recalled for future reference or jobs. Field features may include, but are not limited to:

- Field boundaries
- Weed or insect infestations
- Tile lines or waterways
- Rocks
- Trees
- AccuBoom Spray/No-Spray zones

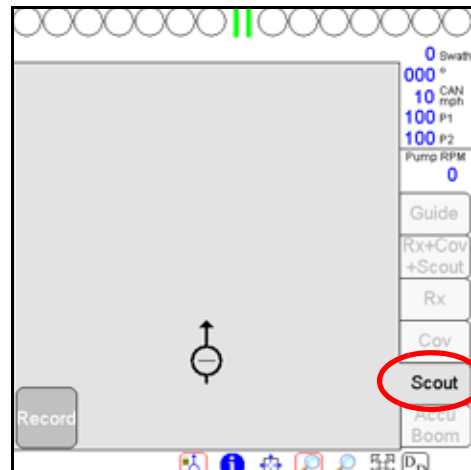

The Scout tab must be active to allow the Viper Pro to record scouting features. The Scout tab must be active and Scouting features must be recorded or imported.

## Marking a Field Boundary

Each job may only contain a single field boundary. Additional zones or features within a field must be setup with new names.

The Viper Pro offers three methods to record field boundaries:

- **Manual Point Entry:** This method allows you to manually set boundary points. Viper automatically connects each point with a straight line to close the field boundary.
- **Auto Point Entry:** This method allows Viper to draw the boundary in real-time as you drive through the field. When the configured boom or implement comes within one boom width of the boundary's starting point, the Viper Pro automatically closes the boundary. The operator may also choose to close the boundary manually.

**Note:** *If a boundary is closed manually, the Viper Pro connects the vehicle's current location to the boundary's starting point with a straight line. The field area within the marked boundary will be included in the zone while area outside of this boundary will not be included. Note the boundary starting point before manually closing a field boundary.*

- **Manual Point Entry - Rubber Banded Zone:** This method allows you to drop boundary points as you are driving the boundary. When you close the boundary, Viper automatically connects the points to draw the boundary.

## How to Mark a Field Boundary

With an active job on-screen:

1. Press the **Scout** tab.
2. Select **Record**, then **Zone**. The Record Field Feature screen displays.

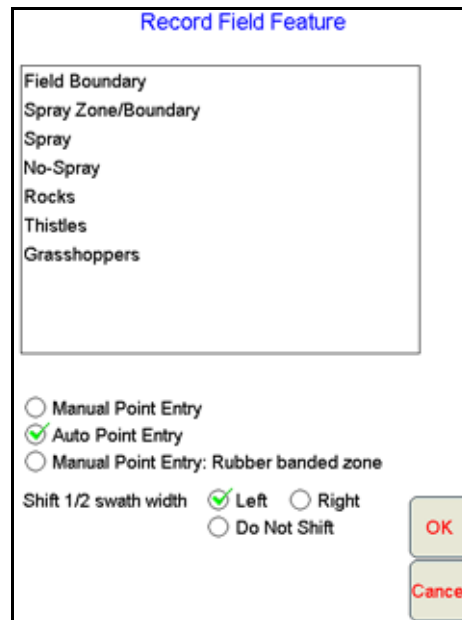

3. Select **Field Boundary**.
4. Select the method best suited to your application.
5. Select an offset shift for the boundary.
  - a. Selecting the **Left** offset places the reference point for recording the boundary at the left boom tip or the left side of the implement.
  - b. Selecting the **Right** offset places the reference point at the right of the boom or implement.
  - c. Select the **Do Not Shift** option to record the boundary at the center of the boom or implement.
6. Press **OK**. Viper begins recording points based upon the selected Point Entry mode.

**Note:** Refer to Chapter 7, *Using AccuBoom™*, for detailed AccuBoom setup and operation and for detailed information on creating AccuBoom Spray/No-Spray zones.

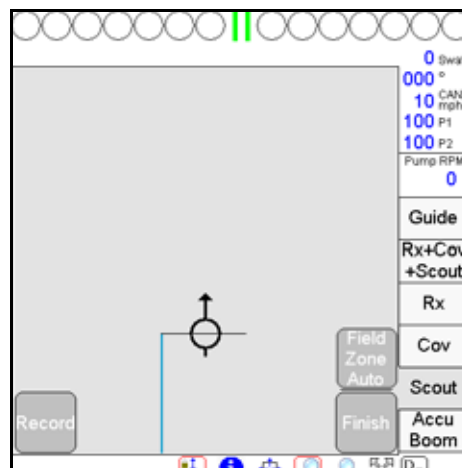

7. Drive the perimeter of the field while keeping the selected reference point along the path of the field boundary.



8. To close the field boundary, select one of the following options:
  - To manually close the field boundary, touch the **Finish** button in the Map area.
  - Press the **Field Boundary** button, typically labeled 'Field Zone Auto.' Viper automatically connects the boundary line from the current position to the boundary starting point.

## Importing a Field Boundary

If a boundary has previously been created from another source and is in the shapefile format (.shp), you can import this boundary.

**Note:** Shapefiles must contain only one polygon. For help using the File Maintenance feature, see Chapter 10, File Maintenance.

### How to Import a Field Boundary

1. Press the **Scout** tab.
2. Select **Record**, then **Zone**. The Record Field Feature screen displays.

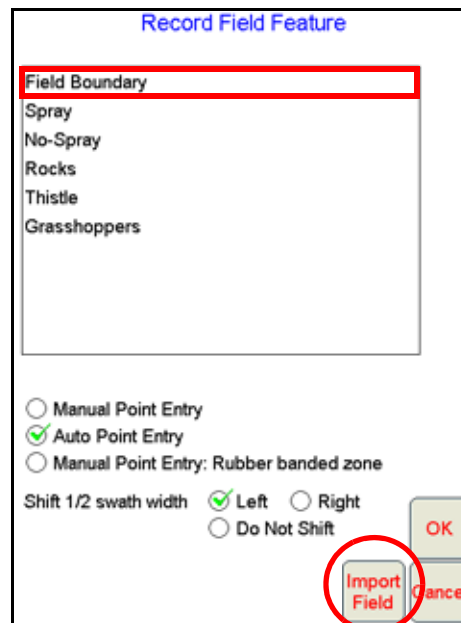

3. Select 'Field Boundary' and then press the **Import Field** button.
4. The Select Field Shape File screen displays.

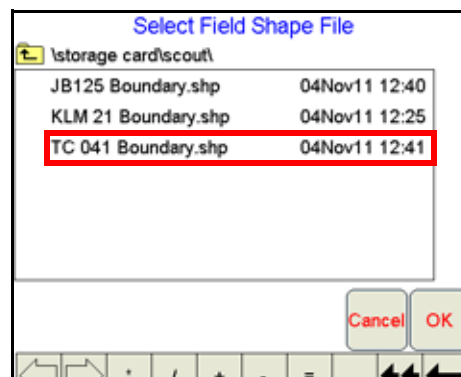

5. Select a file from the list and press **OK**. Viper imports the file into the system.

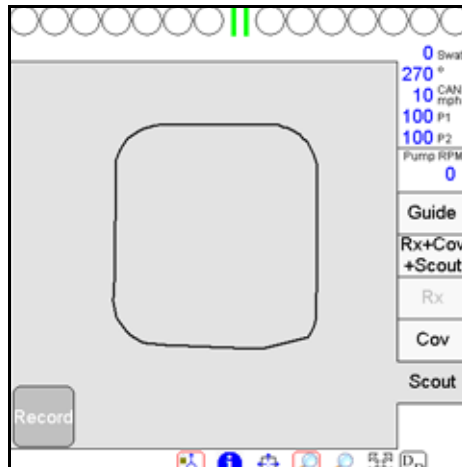

## AccuBoom™ Tab

The AccuBoom tab is not available for Standard AccuBoom applications. The AccuBoom tab displays the current AccuBoom Spray Zone map.

See Chapter 7, *Using AccuBoom™*, for more information about using the AccuBoom feature.

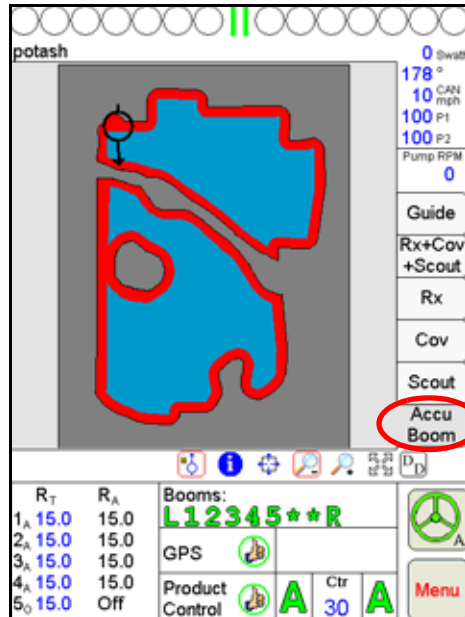

# Menu

Several selections and configuration screens are available through the **Menu** button located in the lower-right corner of the Viper Pro main screen. The Menu is used to start and manage job files, configure several system preferences and features and to shut down the Viper Pro console.

To access these settings and features, touch the **Menu** button to open the first level menu options.

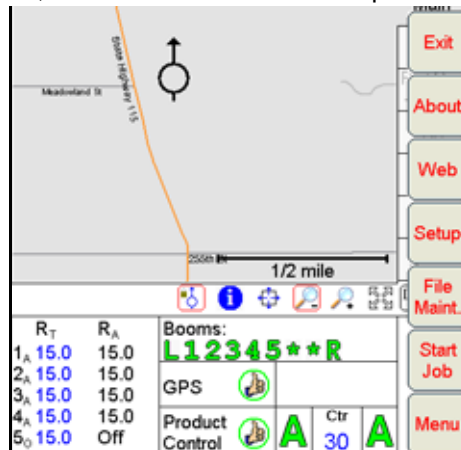

## Exit Button

To close the Viper program, touch the **Exit** button. The following prompt will appear.

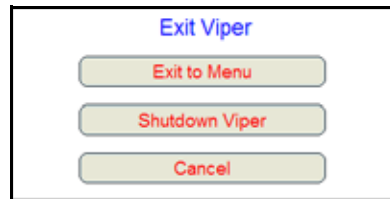

Select **Exit to Menu** to view the Program Selection Menu, **Shutdown Viper** to power down the console, or **Cancel** to resume the Viper Pro program.

**Note:** *If a Job is in progress when the exit button is selected, the Viper Pro will display a warning alerting the operator. Exit the Viper Pro application without closing the job, touch **Yes**. Raven recommends closing any open jobs before exiting the Viper Pro application to avoid losing job information.*



## About Button

Select the **About** button to view the current software and build version installed on your Viper Pro console. The About Viper screen also displays the space remaining on the Viper Pro's internal memory.



The following status indicators may appear when the space available on the Viper Pro's internal memory is running low.

	<p style="text-align: center;"><b>Memory Low</b></p> <p>Less than 16 MB of space remaining</p>
	<p style="text-align: center;"><b>Memory Critical</b></p> <p>Less than 10 MB of space remaining</p>

The Viper Pro automatically checks remaining internal storage space and will display an alert if the internal storage space is almost full. This warning can be cleared by pressing the **OK** button.

## Runtimes

The Application Runtime is the overall time that the Viper Pro application has been in operation on the Viper Pro console. The Version Runtime displays the run time of the current software version installed on the Viper Pro console.

## CAN Firmware Version

This value displays the current version of firmware used for CAN communications.

## BIOS Version

The BIOS version currently used by the Viper Pro console.

## Windows™ OS Version

This value is the image version of the Windows operating system installed on the Viper Pro.



## Display Mode and Brightness

Touch the Adjust Brightness button at the bottom of the About Viper prompt to display the Adjust Brightness settings.



Mode Selection Button -  
Day Mode Enabled

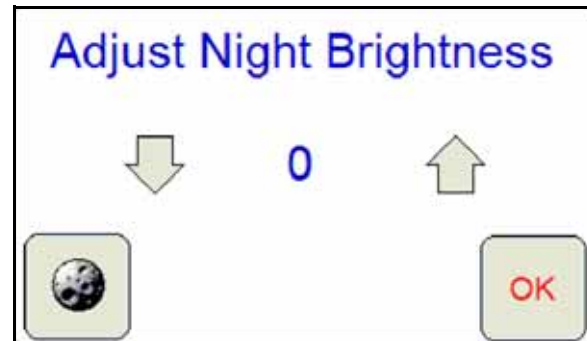

Mode Selection Button -  
Night Mode Enabled

The Adjust Brightness settings prompt displays the following:

- Mode Selection Button - The mode selection button also displays the current mode enabled. Touch this button until the desired mode is displayed.
- Increase/Decrease Arrows - Touch the arrows pointing up and down to either increase or decrease the display brightness. Touch and hold for five seconds to change the brightness value in increments of 5.
- Brightness Value - The current display brightness setting is displayed in the center of the window. In Day mode, this value may be set between 50 and 100. In Night mode, the brightness value may be set between 0 and 100.
- OK - Touch the OK button to accept the current mode and brightness value and return to the Viper Pro main screen.

**Note:** The Viper Pro will always default back to the day mode when powered up or restarted.

## Web Button

If the Field Hub wireless router kit (P/N 117-0171-217), or similar hardware, is connected to the ethernet port on the back of the Viper Pro console, pressing the **Web** button will allow the operator to access the world wide web on the Viper Pro touch screen.

**Note:** Refer to the Field Hub Quick Start Guide (P/N 016-0171-238) for set up and wireless navigation instructions or contact your local Raven dealer for purchasing information.

## Setup Button

The Setup button provides a number of additional selections used to set up the Viper Pro.

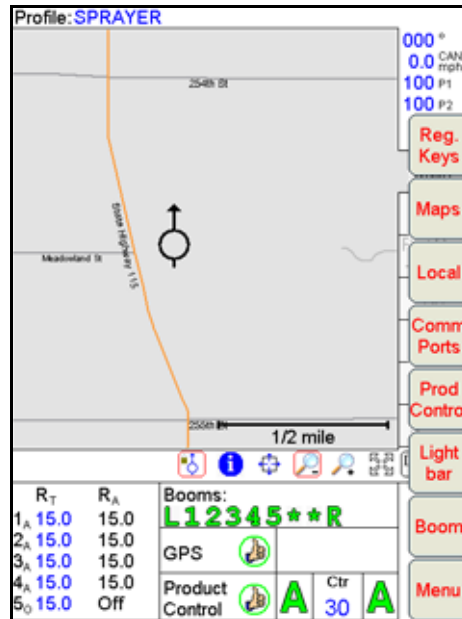

Press the **Setup** button to access the following menu items.

- Registration Keys
- Maps
- Local
- Communication Ports
- Product Control
- Lightbar
- Boom

See the *Setup Menu* section on page 82 for a description of the features accessible through the Setup Menu.

## File Maintenance

The File Maintenance feature allows the operator to transfer files from the Viper Pro to a USB flash drive. In addition, archived files may be transferred back to the Viper Pro console to recall field information or resume previous job applications. See Chapter 10, *File Maintenance*, for a detailed description of the File Maintenance feature.

## Start Job

Select the **Start Job** button to setup and begin a job on the Viper Pro. See Chapter 5, *Using the Viper Pro System*, for detailed information about using the Viper Pro during field applications.

## Setup Menu

### Registration Keys and Feature Activation

The Viper Pro console offers a number of optional features which may be purchased individually and added at any time. To activate a feature not currently enabled on your Viper Pro system, contact your Raven distributor. See Chapter 2, *Installation, Start Up & Registration*, for instructions on registering and activating features on your Viper Pro console.

### Maps

Select the Maps button in the Setup menu to to:

- load and delete streetmaps
- manage scout maps
- manage coverage maps
- manage Prescription maps

To manage maps on the Viper Pro, touch the **Menu** button, then select **Setup** and **Maps**. The menu displays the following map options:

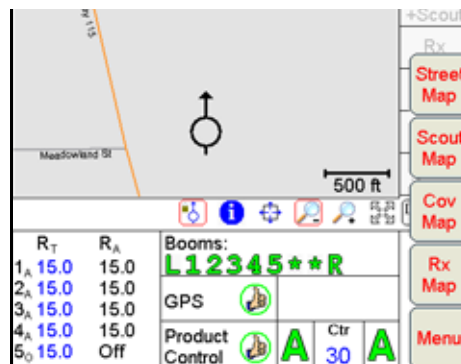

- Street Maps
- Scout Maps
- Coverage Maps
- Prescription (Rx) Maps

## Street Maps

If a county map is loaded on the Viper Pro, the Map area displays the vehicle course direction indicator in relation to the selected street map on the Main tab.

**Note:** *The Main tab is only accessible when a job is not in progress.*

Maps are available free of charge for counties within the United States in a compressed, or “zipped,” format. A program to extract, or “unzip,” these files (i.e. WinZip™) will be required to prepare the files for use with the Viper Pro console.

**Note:** *If your computer does not already have the ability to unzip a file, a trial version of WinZip™ software tool is available at:*

[www.winzip.com](http://www.winzip.com)

*A free version of an unzip program is also available from the following web site:*

<http://www.freebyte.com/fbzip/>

## Downloading Street Maps

To download street maps:

1. Create a folder on your computer in which to store the download files.
2. Access the Tiger web page at:

[http://arcdata.esri.com/data/tiger2000/tiger\\_download.cfm](http://arcdata.esri.com/data/tiger2000/tiger_download.cfm)



3. Select the desired state in the map. The “Download Census 2000 TIGER/Line® Shapefiles” page displays.
4. From the **Select by Layer** drop-down list, select the **Line Features-Roads** option.
5. Click **Submit Selection**. The Available Counties page displays.
6. Check the option for the desired county to download and click the **Proceed to Download** button at the bottom of the list. The Data File Ready page will be displayed.
7. Click **Download File**. The File Download screen displays.
8. Click **Save**. The Save As screen displays.
9. Select the folder created in step 1 and click **Save**. The file is saved to your folder.
10. To download additional street maps, repeat step 5 through 9.

**Note:** *Before loading the compressed map files to the Viper Pro console, extract the map files to the folder you created in step 1.*



### Loading Street Maps to the Viper Pro Console

1. Rename the three files to the name of the county. For example, if you downloaded maps for Dallas county, rename the file "tgr46087lka.shp" to "Dallas.shp."

**Note:** To rename a file, right-click on the file and select **Rename**. Type in the new file name. Be sure to keep the same file extension or the file will not work with your Viper Pro system.

2. Copy the files to the streetmaps folder within the Viper directory of your USB flash drive.

**Note:** The streetmaps folder should be located in: F:\Viper\misc\streetmaps, where F is the root drive letter of your USB device. Do not copy the files into sub-folders. Viper will not be able to locate files within sub-folders.

3. Turn on the Viper Pro console and select **Viper Pro** from the Program Selection Menu.
4. On the main screen, select **Menu**, then **File Maint.**, and then select the option labeled **Advanced File Maintenance**.
5. On the Advanced File Maintenance screen, select:
  - a. **Street Map**, then **Copy** or **Move**.
  - b. To move files from the USB drive to the Viper Pro, select the **External --> Viper** option., and **Copy All** or **Copy Selected**.
  - c. Viper will upload streetmaps files to the internal memory.
6. Press **OK** to exit the File Maintenance feature.
7. Select **Menu**, then **Setup, Maps, Street Map, Install Streets**, and **OK**. Viper loads the map files for viewing on the Main tab of the Viper Pro.

**Note:** When the street map is loaded, the Viper Pro changes the files to a .sct format.

### Deleting Street Maps

To delete a street map from the Viper Pro console:

1. Select **Menu**, then **Setup, Maps, Street Map, Delete Streets**, and **OK**. Viper deletes the .sct files from the console.
2. Delete the associated map files from the internal storage using the Advanced File Maintenance feature if you no longer need them.

### Scout Maps

Features within a field may be pre-recorded, or scouted, using the Viper Pro console. These features can be saved on the Viper Pro console and recalled at a later date for other field applications. The Viper Pro offers up to 16 different field feature types with four Viper presets and 12 user selectable features.

Field features may include, but are not limited to:

- weed or insect infestations
- tile lines or waterways
- rocks
- trees

Scout map features may be recorded at any time during an active job.

## Configuring the Scout Map

To setup features and select a color to display recorded features:

1. Touch the **Menu** button, then select **Setup, Maps,** and **Scout Map**. The Enter Feature Names and Colors screen is displayed.

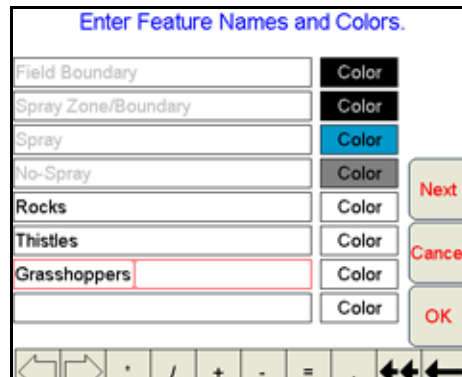

2. Using the on-screen keyboard, enter the name of the feature in an available field.
3. Press the corresponding **Color** button. The Feature Colors screen displays.



4. Select a color for the feature and press **OK**. Viper assigns the color to the feature and returns to the Enter Feature Names and Colors screen.
5. To setup more field features, repeat step 2 through 4.
6. Press **OK** when you have finished entering the features. Viper saves the feature information and returns you to the main screen.

## Recording Field Features

Field features are recorded with the Viper Pro in the same way as recording a Field Boundary. For a step-by-step procedure for recording field features, review the *How to Mark a Field Boundary* section on page 75.



## Coverage Maps

The Coverage Map feature of the Viper Pro creates an as-applied map for the job in progress. After the job is completed, the map may be transferred from the Viper Pro console to a home or office PC for viewing and printing application reports for each job.

In addition to the job reports, the Coverage Map displays real-time product rate information for operator reference. Areas where the rate of product application is not within acceptable limits are displayed during the application. This information can help an operator make adjustments to product application on-the-fly.

Coverage Map information is displayed on the Guide, Rx+Cov+Scout, and the Cov tabs during job applications.

### Setting the Coverage Map Percentages and Colors

To setup the preferences for the Coverage Map:

1. Select **Menu**, then **Setup, Maps**, and **Cov Map**. The Coverage Maps Colors screen displays.



2. Using the screen keyboard, enter the maximum application rate allowed above the target application rate.

**Note:** The default setting is 120%.

3. Using the screen keyboard, enter the minimum application rate allowed below the target application rate.

**Note:** The default setting is 80%.

4. Press the **Select** button next to each Rate field to change the color displayed on the Coverage Map.
5. Press **OK** when you have finished. Viper saves the coverage map preferences.



## Zero Rate Tolerance

Touch the **Next** button on the Coverage Map Colors screen to display the Zero Rate Tolerance settings for each product controlled by the Viper Pro.

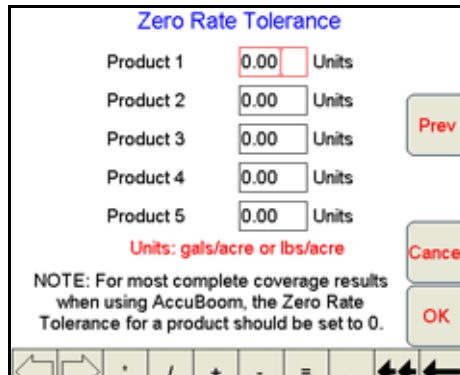

The Zero Rate Tolerance allows the operator to set a maximum level that the Viper Pro can detect without recording coverage map information.

### For Example:

During product application in rough field areas, excess “bouncing” may cause the encoder to send out false pulses, which the Viper Pro records as an over application of the area. If these pulses are recorded in a zero rate zone, the Viper Pro Coverage Map report will display an over application in this area. The Zero Rate Tolerance feature allows the operator to set a threshold for encoder pulses which can help eliminate “chatter” reported by the Viper Pro.

Each product may be set up with a different Zero Rate Tolerance to ensure each product is displayed accurately on the Coverage Map. On some machines, the main bin will supply a relatively high volume of product and the tolerance may be set relatively high. Other bins that supply micro-nutrients may apply material at a much lower rate and will require rate tolerance setting.

### Setting the Zero Rate Tolerance

1. Select **Menu**, then **Setup, Maps**, and **Cov Map**. Press the **Next** button. The Zero Rate Tolerance screen displays.
2. Using the screen keyboard, enter the appropriate Zero Rate Tolerance setting for each product.

## Prescription (Rx) Maps

Prescription maps used on the Viper Pro console must be in the shapefile format to allow the console to display and automatically adjust product application rates. Prescription maps must be created using GIS (Geographic Information System) software capable of creating shapefiles. These shapefiles must be in the polygon shape format that complies with the ESRI (Environmental Systems Research Institute) shapefile specifications. Shapefiles must also be in the WGS84 datum.

Prescription maps should contain as few zones as possible. Creating maps with too many zones may affect the Viper Pro’s performance. Raven recommends using the width of your boom or implement as a gauge for creating zones on the Prescription Map. The smallest zone on the map should be no smaller than the width of the equipment applying the product.

**For Example:**

If your machine’s swath width is 90 feet, zones on the Prescription Map should be no less than 90 feet wide.

Once created, the Prescription Map shapefiles (.shp, .shx, .dbf) files must be copied to the RxMaps folder on the USB flash drive used with the Viper Pro.

Access the Rx Map menu to setup the following features of the Prescription Maps:

- Rx Look Ahead Values
- Prescription Map Display Colors

**Multi-Product VRA**

The Viper Pro is capable of controlling up to five products in reference to individual maps for each product or a single map containing the rate information for each product in the .dbf file.

The following table is an example of the .dbf file for a single map that contains multiple product information.

Nitrogen	Potassium	Phosphorus	Lime
100.0	20.0	15.0	750.0
125.0	17.0	33.0	200.0
85.0	45.0	21.0	600.0
50.0	0.0	18.0	925.0

**Note:** *If the prescription map contains zero rate zones, the system must have either a PWM or Fast Valve controlling product. You must also program the valve type to C-PC (PWM Close) or C-FC (Fast Close) mode, depending upon which valve is installed in the system.*

*If the system contains a fast valve, the valve must be plumbed into the main product line. You cannot plumb the valve into a bypass line.*

**Accessing the Rx Map Menu**

1. Select **Menu**, then **Setup, Maps**, and **Rx Map**. The Rx Map menu appears.

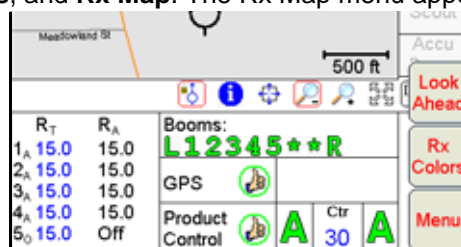

**Rx Look-Ahead**

The Rx Look-Ahead setting is the number of seconds (determined by vehicle speed) the Viper Pro is allowed to scan in front of the vehicle’s current position to find rate changes on a prescription map. This feature may help to compensate for the time it takes a valve to fully adjust to a different rate.

**Note:** *The Rx Look Ahead setting only affects products controlled in reference to a prescription map*

**For Example:**

If the control valve takes four seconds to adjust to a rate change, setting an Rx Look Ahead value of 2 seconds will allow Viper to begin adjusting the valve prior to the vehicle entering the new rate zone.

**Setting the Look-Ahead Value**

1. Select **Menu**, then **Setup, Maps, Rx Map**, and **Look Ahead**. The Look-Ahead Seconds screen displays.

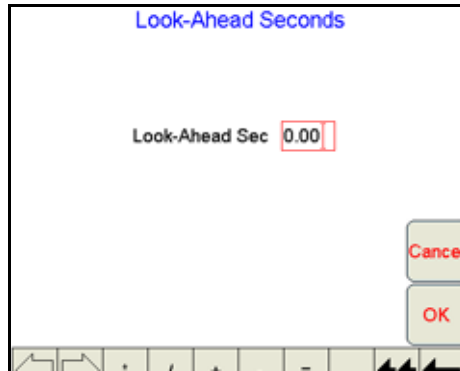

2. Using the screen keyboard, enter the look ahead value in the Look-Ahead field.
3. Press **OK**. Viper saves the setting and returns to the main screen.

**Rx Map Colors**

The colors displayed for different rate zones on a prescription map may be modified for the operator's preferences.

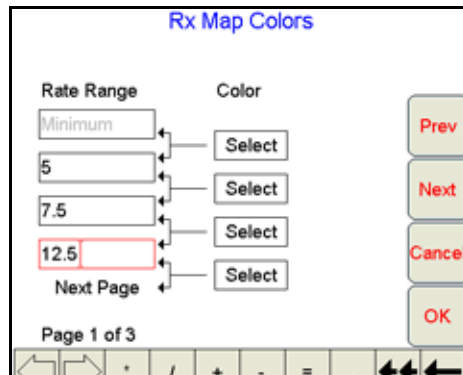

If no color template is selected by the operator, the Viper Pro will use the default colors.

**Adding a Rx Color Template**

1. Select **Menu**, then **Setup, Maps, Rx Maps**, and **Rx Colors**. The Select Rx Map Colors screen displays.



2. Press **Add**. The Rx Map Colors screen displays.



- Using the screen keyboard, enter a name for the new color template.

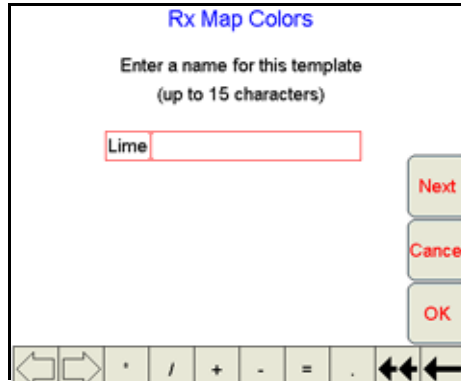

- Press **Next**. The Rate Range and Color selection screen displays.

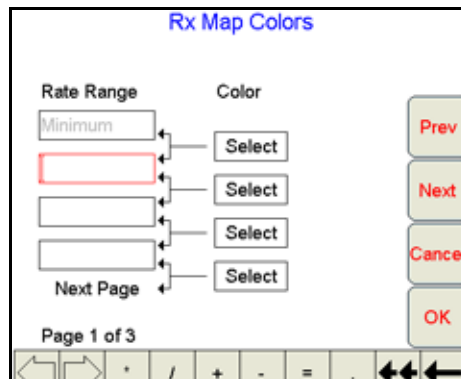

- Using the screen keyboard, enter a value for the upper limit in the first Rate Range field.
- Press **Select**. The Rx Map Colors screen displays.

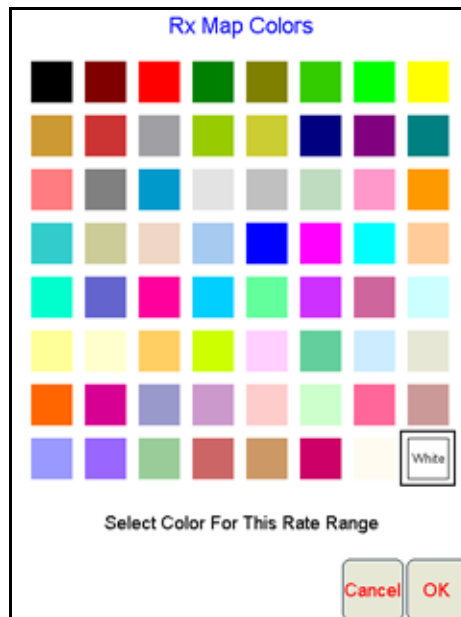

- Select a color and press **OK**.
- To add more values as ranges, repeat step 4 through 7. Making sure to select a color for the Minimum Rate Range.

**Note:** The last range you enter will be the maximum value for the range. You can enter up to 10 ranges for the color template.

9. Press **OK**. A confirmation screen displays.
10. Press **OK**. Viper saves the Template.

### Editing a Rx Color Template

1. Select **Menu**, then **Setup, Maps, Rx Maps**, and **Rx Colors**. The Select Rx Map Colors Template screen displays.
2. Press **Edit**. The Select Existing Rx Color Template screen displays.



3. Select the template to edit from the list and press **OK**.
4. If necessary use the screen keyboard to edit the template name.
5. Press **Next**. The Rx Map Colors screen displays.
6. Use the screen keyboard to edit the range values and color selections.
7. Press **OK**. Viper saves the updated template information.

### Deleting a Rx Color Template

1. Select **Menu**, then **Setup, Maps, Rx Maps**, and **Rx Colors**. The Rx Map Colors screen displays.
2. Press **Delete**. The Select Rx Color Template to Delete screen displays.

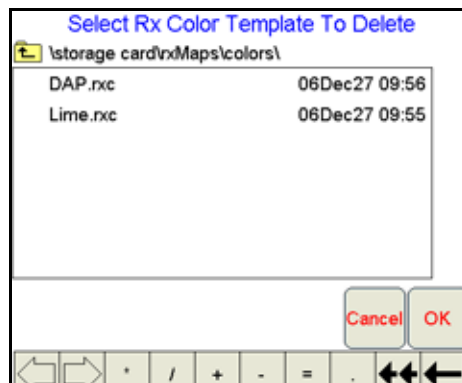

3. Select the template to delete from the list and press **OK**. A confirmation screen displays.
4. Press **Yes**.
5. Press **OK**. Viper deletes the template from the system.



# Local Settings

The Local settings allow the operator to set up preferences for:

- Language
- Profile Configuration
- Units Configuration
- Time Zone Configuration

## Language

The Viper Pro offers the following languages for operation:

- English
- Portuguese
- Spanish

### Choosing a Language

1. Select **Menu**, then **Setup**, **Local**, and **Lang**. The Language Setup screen opens.
2. Select the desired language for display on the Viper Pro console. Press **OK**.
3. A confirmation screen displays. Press **OK**.

## Profile Configuration

Profiles allow the operator to save various machine setup and configuration information. If the Viper Pro console will be used with multiple machines, the profile for that vehicle can be re-applied to quickly configure the Viper Pro for the machine.



The Viper Pro saves the Boom and Comm Port configurations in the Profile.

**Note:** *Profiles do not store any information contained in the CAN nodes.*

### Saving Profile Information

1. Select **Menu**, then **Setup**, **Local**, **Profile**, and **Save Profile**. The Save Profile screen opens.
2. Using the screen keyboard, enter a name for the profile.
3. Press **OK**. A confirmation screen displays.

**Note:** *Before saving a profile, make sure that all settings are correct.*

4. Press **OK**. Viper saves the profile information to the system.

### Loading a Saved Profile

1. Select **Menu**, then **Setup, Local, Profile**, and **Load Profile**. The Select Profile screen displays.
2. Select a profile from the list.

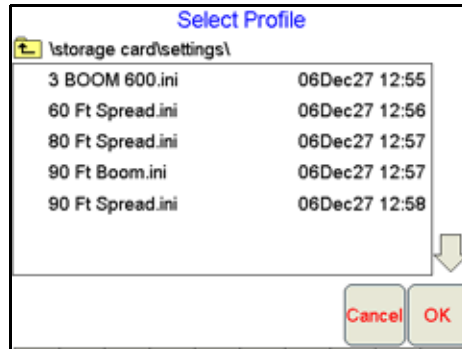

3. Press **OK**. A confirmation screen displays.
4. Press **OK**. Viper restarts with the new profile loaded.

### Display Units Configuration

The following systems are available for displaying measure and rate on the Viper Pro:

- English: This setting displays units in feet, miles, ounces, etc.
- Metric: This setting displays units in meters, kilometers, liters, etc.



**Note:** The Viper Pro default setting is English.

### Setting the Unit of Measurement

1. Select **Menu**, then **Setup, Local**, and **Units**. The Display Units screen displays.
2. Select the desired system of measurement for use with the Viper Pro.
3. Press **OK**. Viper saves the setting.



## Time Zone Configuration

To configure the Viper Pro for the time zone in which the console will be operating. Select the **Time Zone** button in the Viper Pro Menu.

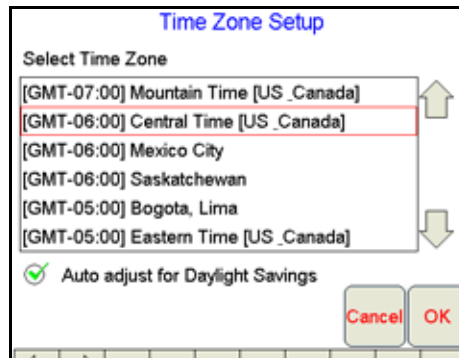

Using the correct time zone ensures that the correct date and time display on the Viper Pro console. The standard default setting is for Central Time Zone and automatically adjusts for Daylight Savings.

### Setting the Correct Operating Time Zone

1. Select **Menu**, then **Setup**, **Local**, and **Time Zone**. The Time Zone Setup screen displays.
2. Select a time zone from the list. You may need to press the **UP** or **DOWN** scroll the display and view more time zones.
3. Select the **Auto adjust for Daylight Savings** option to allow Viper to automatically adjust for daylight savings.
4. Press **OK**. Viper saves the time zone settings.

---

## *Serial Communication Port Setup*

The Viper Pro contains three serial ports that can be configured to connect with various external devices. The serial ports are:

- GPS Comm Port
- Console Comm Port
- Auxiliary Comm Port

The Comm Port setup can be accessed through the menu setup program. To configure the serial communications ports, press **Menu**, **Setup**, **Comm Ports**. The following screen will be displayed.

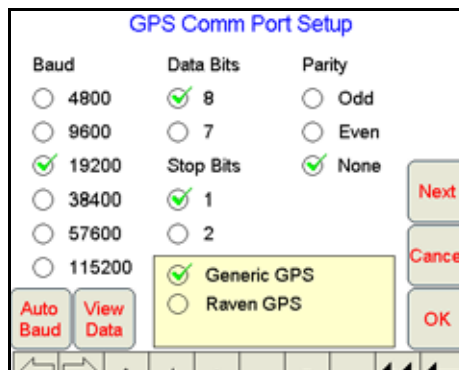



## GPS Comm Port Setup

Use the GPS Comm Ports Setup screen to modify the communication settings. These settings include:

- Baud Rate
- Data Bits
- Parity
- Stop Bits

Communication settings must match the receiver settings exactly for proper communication between the Viper Pro and the connected DGPS unit. Real-time communication strings may also be displayed by the Viper Pro console.

Use the GPS Comm Port Setup screen to setup:

- Generic (Non-Raven) GPS, also RPR 410, Phoenix 300
- Raven GPS
- AutoSteer

### Generic (Non-Raven) GPS Setup

The **Generic GPS** option allows the operator to configure the communication settings for the Viper Pro for the GPS receiver providing GPS data.

**Note:** *The DGPS Receiver must be powered up and connected to the 'DGPS' connector on the Viper Pro Main Interface Cable (P/N 115-0171-746). The receiver must also output the GGA, VTG, and either the RMC or ZDA NMEA messages to communicate properly with the Viper Pro.*

### Setting up the GPS Comm Port to a Non-Raven DGPS Receiver

1. Select **Menu**, then **Setup**, and **Comm Ports**. The GPS Comm Port Setup screen displays.
2. Select **Generic GPS**.

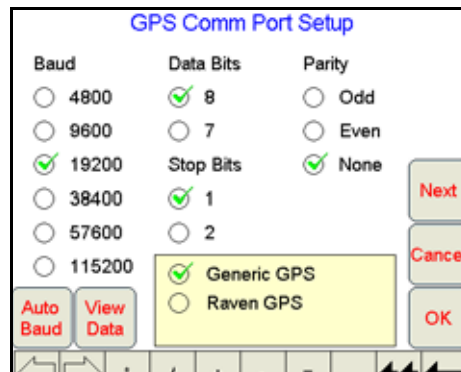

3. Press **Auto Baud**. Viper establishes communication with the DGPS receiver.
4. Press **OK** once the communication is established.

**Note:** *If no communication is established, Viper Pro will display a 'Not Found' message. Press **OK** and then re-check the receiver and cables and repeat step 3.*

If an optional SmarTrax, automated steering system, will be used with the Viper Pro system, for SmarTrax software versions:

- 3.2 and lower, set the baud rate to 38400.
- higher than 3.2, set the baud rate to 115200.

### Raven GPS Setup

Select the **Raven GPS** option if a Raven DGPS Receiver is connected to the Viper Pro. This option will auto-configure the communication ports for the following receivers:

- RPR 100S
- RPR 100G
- Invicta 110
- Invicta 115
- Invicta 210
- Invicta 310
- Phoenix 50
- Phoenix 200
- Phoenix 250

Make sure that the Raven receiver is properly connected and powered up before configuring it with the Viper Pro system.

### Auto-Configuring a Raven DGPS Receiver

1. Select **Menu**, then **Setup**, and **Comm Ports**. The GPS Comm Port Setup screen displays.
2. Select **Raven GPS**. Viper will automatically configure the port on the receiver with the following settings:
  - Baud = 19200
  - Data Bits = 8 bits
  - Stop Bit - 1
  - Parity = None

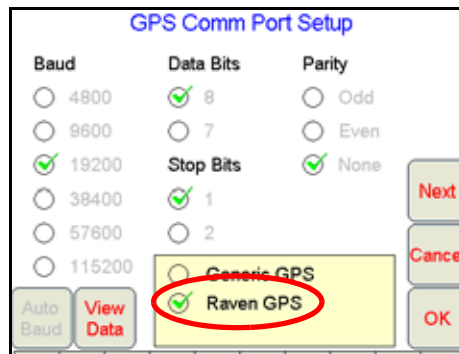

3. Press **OK** when the Viper Pro system is finished configuring the receiver.

### AutoSteer

If the Viper Pro console will be used with a FarmPRO system, be sure to select the AutoSteer option. This option configures the GPS Comm Ports for the FarmPRO system.

## Console Comm Port Setup

If a Raven Serial Control Console is selected as the Product Control option, pressing the **Next** button on the GPS Comm Port Setup screen will display the Console Comm Port Setup screen.

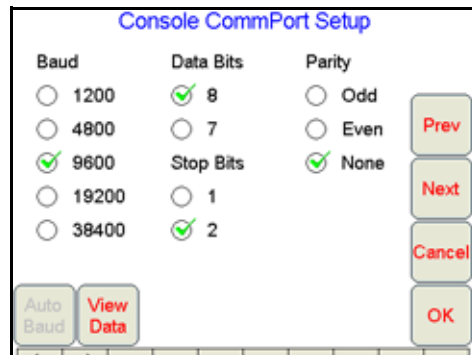

**Note:** The Console Comm Port Setup screen will not be displayed if the Viper is connected to a Raven CANbus system. If the Viper is connected to a CANbus system, skip to the Auxiliary Comm Port Setup section on page 97.

### To setup the Console communication:

1. Set the following communication settings:
  - Baud = 9600
  - Data Bits = 8
  - Parity = None
  - Stop Bits = 2
2. Press **View Data** to view the communication strings coming from the Console connection.

**Note:** If no data appears on the View Data screen, press **Cancel** and re-check the serial control console and connections. Verify that the console is set up properly to communicate with the Viper Pro and then repeat step 2.

3. Press **Next** to go to the next Comm Port Setup Screen.

## Auxiliary Comm Port Setup

Use the Auxiliary Comm Port Setup screen to configure auxiliary communication ports if necessary. Touch **Next** to advance to the next Comm Port Setup screen.

## Weather Module Setup

If the optional Weather Module activation key has been entered on the Viper Pro, the Weather Module Setup screen will be displayed.

Refer to Appendix L, *Weather Station*, for more information.

## Configuring Viper Pro for Lightbar Guidance

Viper Pro allows you to use two Guidance systems, either separately or together.

- On-screen lightbar
- External lightbar

### On-Screen Lightbar

Viper Pro displays a lightbar at the top of the screen with the Guide tab selected. To use the on-screen lightbar, a DGPS receiver capable of sending output messages at a minimum of 5 Hz must be connected to the Viper Pro.

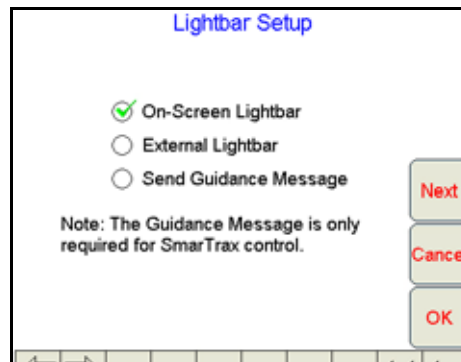

### Configuring the On-Screen Lightbar

1. Press **Menu**, then **Setup**, and **Lightbar**. The Lightbar Setup screen displays.
2. Select the **On-Screen Lightbar** option and then press **Next**. The On-Screen Lightbar Setup screen displays.

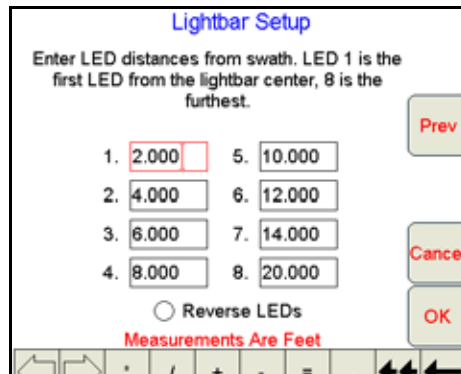

3. Using the screen keyboard, enter the LED distances from the swath pattern. LED 1 is the first LED from the lightbar center. LED 8 is the farthest LED from the lightbar center.

**Note:** The default settings for the on-screen lightbar are typically used. Only perform step 3 to modify the lightbar display.

## External Lightbar

In order to use an external lightbar, a Raven GPS receiver must be installed and both the receiver and lightbar must be properly configured. See the *GPS Comm Port Setup* section on page 95 for more information about configuring an external lightbar.



Press the **Next** button. The External Lightbar Setup will appear. Select the desired comm port.

## Send Guidance Message

The Viper Pro guidance system is capable of working with the SmarTrax automated steering system. In order for the Viper Pro to send guidance messages to the SmarTrax system, The **Send Guidance Message** option must be selected.



## Boom and Implement Setup

The Boom Setup feature allows you to enter the width of the entire boom as well as the width of each individual boom section.

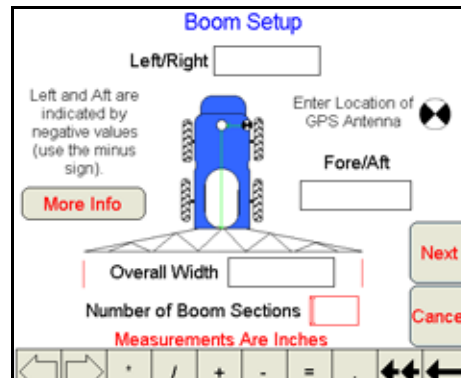

**Note:** This screen sets up the overall machine location in relation to the GPS antenna.

You must also enter the center (midpoint) for the entire boom in relationship to the GPS antenna. If the boom center is to the left and behind the GPS antenna, enter negative values in both of these fields. You must use the negative sign in front of these numbers when entering the values. Be sure to enter the values in the correct unit of measurement you selected on the Units Configuration screen. If you have not specified a preferred unit of measure, the default is English. See the Units Configuration section in this chapter for more information.

### Setting up Booms

1. Select **Menu**, then **Setup**, and **Boom**. The Boom Setup screen displays.
2. Using the screen keyboard, enter the left or right location of the center of the entire boom in relationship to the GPS antenna in the **Left/Right** field. If the center of the boom is to the left of the antenna, enter a negative number in this field.

**Note:** Press the **More Info** button to see the Boom System Setup Information (including the relationship of the boom to the GPS antenna).

3. Using the screen keyboard, enter the fore and aft location of the center of the entire boom in relationship to the GPS antenna in the **Fore/Aft** field. If the boom is behind the GPS antenna, enter a negative number in this field.
4. Using the screen keyboard, enter the overall width of the booms in the **Overall Width** field.

**Note:** The "Overall Width" is the machine width that is used for Guidance control. This width does not have to equal all of the boom sections totaled.

- Using the screen keyboard, enter the total number of boom sections in the **Number of Boom Sections** field. The total number of booms may include “skipped” boom sections in some cases.

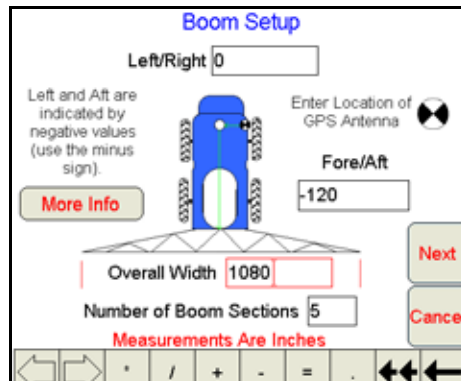

- Press **Next**. The Boom Section Setup screen displays.

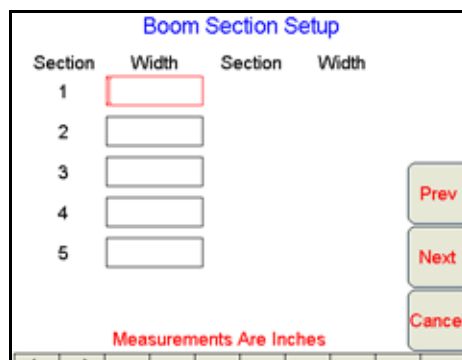

- Using the screen keyboard, enter the width of each boom section in the corresponding box.

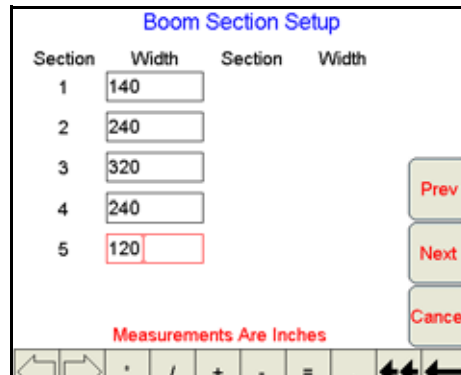

**Note:** For skipped boom sections, enter a width value of “0”.



8. Press **Next** when you have entered all of the boom information. The boom summary screen displays.

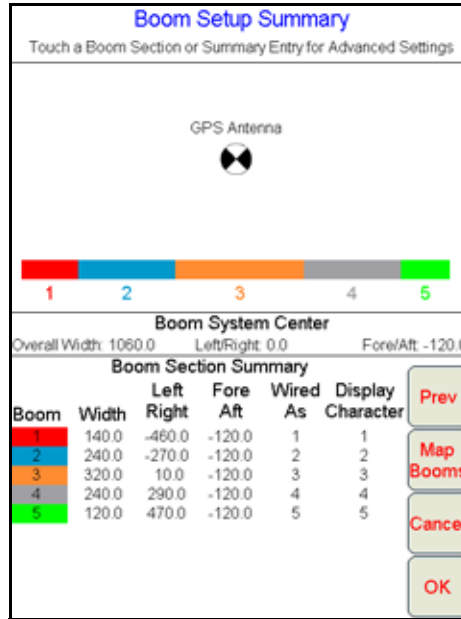

9. Press
  - a. **OK** to accept the current boom setup
  - b. **Map Booms** to change the display characters on the booms
  - c. Press on a **Boom Section** or **Summary Entry** for Advanced Settings of the selected boom section.

## Boom Mapping

The boom mapping feature allows you to change the order of the booms and the display number of the boom. It also allows you to change the boom order from a logical left-to-right order to a special boom configuration.

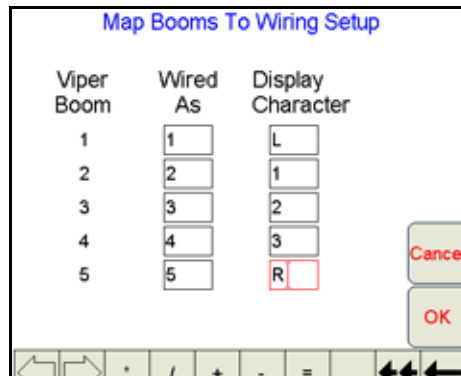

Viper allows you to map up to 10 booms using this screen. You can use the 'Wired As' column to change the order of the booms. For example, if you want to change the order of the booms that you have connected, enter a new ordering scheme in the 'Wired As' column.

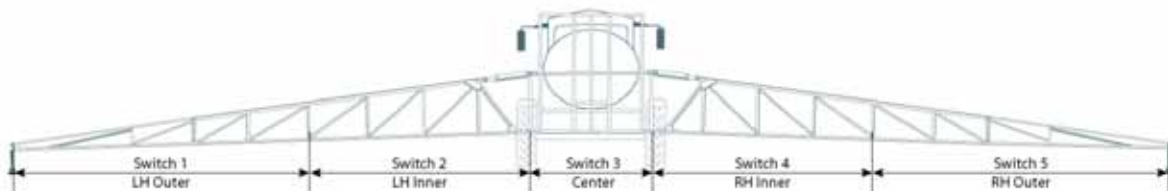



You can also use the 'Display Character' column to change the display number of the boom. For example, you can change boom 1 to L to signify that boom 1 is the left-fence row boom. You will then need to change Boom 2 to Boom 1.

**Note:** You can only use the characters 0, 1, 2, 3, 4, 5, 6, 7, 8, 9, L, R, and \* to label the booms. Use \* for skipped booms.

See the table below for an example of boom mapping information.

Logical	Wired As	Display Character
1	1	L
2	2	1
3	3	2
4	4	3
5	5	4
6	6	5
7	9	R
8	8	*
9	7	*

### Mapping the Booms

1. From the Boom Setup Summary screen, press the **Map Booms** button. The Map Booms to Wired Setup screen will display.
2. Change the order of the booms by entering a new order number in the 'Wired As' fields.
3. Change the display number for each boom by entering the new boom number in the 'Display Character' fields.

**Note:** Viper will not allow 'Wired As' sections to be skipped. For example, if you have 3 boom sections, 'Wired As' must be 1, 2, and 3 in any order. You could not have these three sections 'Wired As' 1, 2, and 4. To skip a boom section, a boom must be configured with '0' width.

4. If you have more than five booms, press **Next** to change the 'Wired As' or 'Display Character' for booms 6 through 10. If not, proceed to step 5.

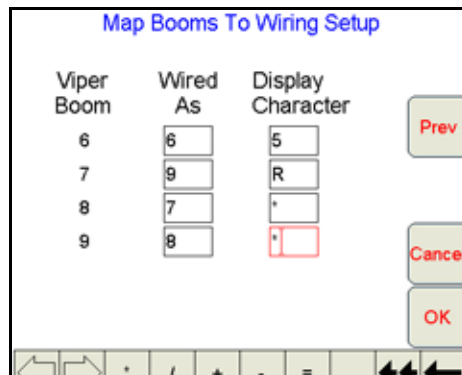

**Note:** Raven boom sense wires are color coded as follows:  
Boom 1 - Black

- Boom 2 - Brown
- Boom 3 - Blue
- Boom 4 - Black/White
- Boom 5 - Brown/White
- Boom 6 - Blue/White
- Boom 7 - White/Black
- Boom 8 - White/Brown
- Boom 9 - White/Blue
- Boom 10 - Pink

5. Press **OK**. The Boom Setup Summary screen displays. To save the boom setup as it appears, press **OK**.

## Advanced Settings

The standard configuration of booms is with the booms end-to-end with no overlap or skips. If you have a special application where the booms are not in this order, you will need to use this Viper Pro feature to configure your booms.

1. Select **Menu**, then **Setup**, then **Boom**, then **Next**, and **Next**. The Boom Setup Summary Screen will display.

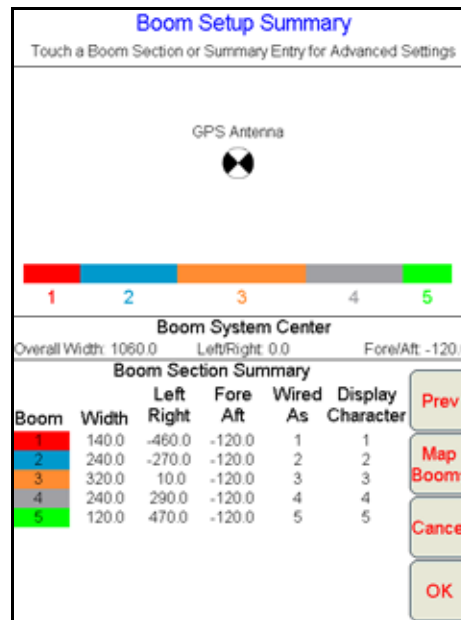

2. From the Boom Setup Summary screen, press on a **Boom Section** or **Summary Entry**. The Boom Section Settings screen for the selected boom will display.

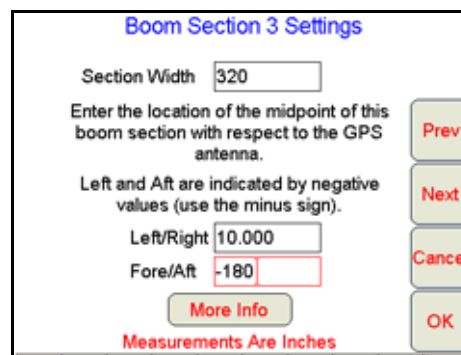

3. Using the screen keyboard, enter the new **Section Width** for the boom section.

4. Using the screen keyboard, enter the new **Left/Right** value for the center of the boom section in relation to the GPS antenna if the boom is to be offset from a standard configuration. Press the **More Info** button to see the Boom Section Setup Information (including the relationship of the boom to the GPS antenna).
5. Using the screen keyboard, enter the new **Fore/Aft** value for the center of the boom section in relation to the GPS antenna if the boom is to be offset from a standard configuration.
6. Press
  - a. **Next** to go to the next boom section to the right.
  - b. **Previous** to go to the previous boom section to the left.
  - c. **OK** to save the new settings. If you enter OK, the revised Boom Setup Summary will display.

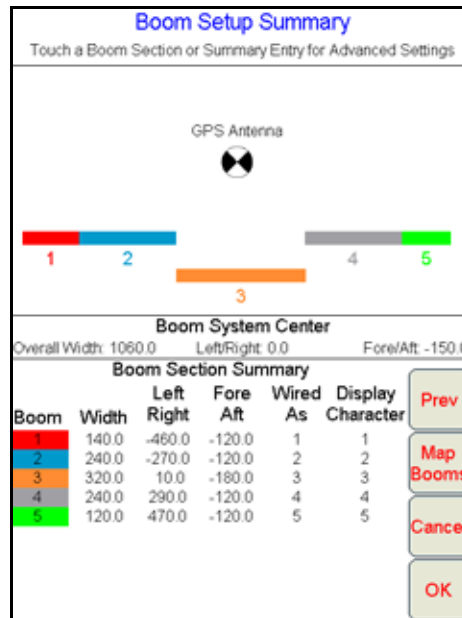

7. Press **OK** to save the boom settings.



---

## CHAPTER

# 5

## *Using the Viper Pro System*

---

After you have learned to navigate the Viper interface, you are ready to start using the system.

Please be aware that once you have completed certain fields during the job setup process, the Viper Pro system will automatically fill in the fields for you with the same contents the next time you start a job. You can make changes to these fields when you go through the setup if you wish to do so.

Examples of these automated fields include:

Product Application, Swath Guidance Type, AccuBoom Control, Swath Pattern, AccuBoom Spray/No-Spray, Number of Products, Product Name, Product Chaining, Chained Product Name, and Enable Auto Advance. You will see these fields as you go through the process of starting a new job. The next time you start a new job, these fields will automatically be filled in for you with the selections you made while setting up the previous job.

---

### *Jobs*

A job is a collection of information about the area of a field in which you are using Viper Pro to apply a product. This information includes:

- Prescription map information
- Product controller system information
- Boom control information
- Application information

From the Menu button on the Viper screen, you have the option to:

- Start a new job
- Open an existing Job, if you have one saved
- Create and edit application report information for Jobs in progress

# New Jobs

Viper allows you to either start a new job from scratch or to start a new job using an existing job boundary. Once you have opened a job, you can access the tabs displayed on the main screen. Your access to the tabs depend upon the features you purchased with the Viper Pro system. When you start a new job, Viper uses the current date and time as the job name. You can change the job name to reflect your new job.

**Note:** *If you are running the Viper Pro system with a Raven CANbus system, make sure that all nodes have been correctly programmed and that they are recognized by the Viper Pro. Review Chapter 3, CAN (Controller Area Network) Setup, for more information about programming and configuring a CANbus system.*

You can select different options to run for the job. The following features are available:

- Product Application
- Swath Guidance
- AccuBoom Control

## Product Application

The Product Application feature allows you to:

- Communicate with a Raven product control system
- Log an application
- Variable rate with reference to a prescription map

If you have a multi-product vehicle and you want to variable rate more than one product, you must purchase the multi-product VRA feature.

Depending upon the type of Raven console you have your Viper Pro console connected to, you can apply a number of different products.

If you are connected to a Raven single product console or a single product Raven CANbus system, you will only be able to apply one product. You will not have the ability to apply multiple products.

If you are connected to a Raven multiple product console or a multiple product CANbus system, the Viper Pro system can control up to five products.

Viper handles the product selection in a sequential manner, so you must select the location on the unit from where the product is applied. If you are using a multiple product controller or CANbus system and you want to apply only products 4 and 5, you must select 5 for you product selection. If you want to apply products 1 and 2, you should still select 5 for your product selection.

The product selection screen references the number of product control channels on the vehicle, not the actual number of products you are applying. For example, if you are applying only product 1, but the tank contains a mixture of three different chemicals, you must enter a 1 in the product selection screen. This screen will only allow you to enter the number of products available for application.

The Product Selection screen also allows the user to select the **Enable Product Chaining** option. With this option selected, the user will be able to select which products to chain together and set the sequence in which the products will be used. See the Product chaining section in Chapter 5 for more information on this feature.

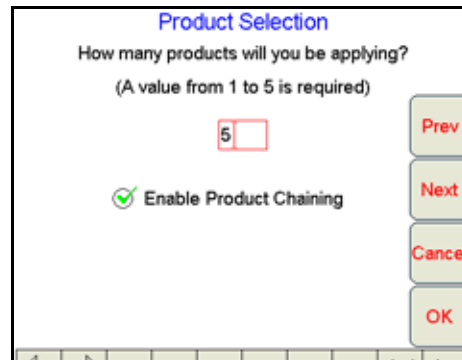

## Swath Guidance

The Swath Guidance feature allows you to use the Guidance CDI and on-screen lightbar. The Viper console is capable of running several swathing patterns.

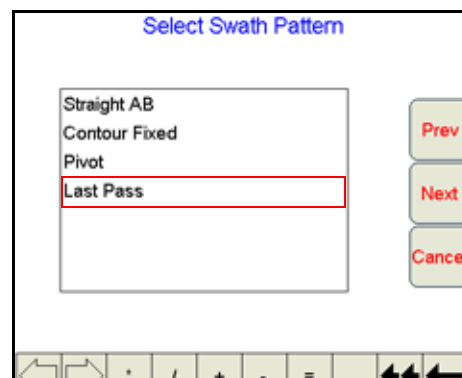

## AccuBoom™ Control

The AccuBoom Control option allows the Viper console to automatically turn the boom sections on or off by referencing the coverage map. When AccuBoom sees from the coverage map that the boom has entered an area where product has previously been applied, it turns the boom section off. When the boom section leaves the previously applied area, AccuBoom turns the boom section back on.

**Note:** *AccuBoom turns booms off when you go outside an Rx Map. AccuBoom will also turn boom sections off when entering zero rate zones on an Rx map if Enable Zero Rate Shut-off has been enabled in the AccuBoom setup.*

AccuBoom initially creates a 5 MB file with a .bct extension that contains detailed information about the boom section coverage for a specific job. AccuBoom saves this file in the Coverage folder on the internal storage memory. If the field exceeds the size of the original AccuBoom file, Viper will automatically increase the file size to cover the entire field area.

See Chapter 7, *Using AccuBoom™*, for more information on using the AccuBoom feature with the Viper Pro console.

## Product Chaining

The product chaining feature allows you to chain together product tanks or bins when applying product to a field. When one tank or bin runs out, Viper automatically switches to another tank or bin and keeps applying product. This reduces trips to refill product.

**Note:** *The products being chained must have their valve type setup as either “Fast Close” or “PWM Close” before enabling product chaining.*

*The Vac/Bin Alarm and Low Tank Alarm must be set up and turned on before beginning product chaining if either of these options is selected as an Auto Advance method.*

*The tank volume should be set up before starting a job. If advance on low tank alarm is selected and the tank volume is zero, bin chaining will immediately advance product control to the next tank.*

*If Advance on Bin Level Sensor Alarm is to be used, all products in the chain must be equipped with a bin level sensor.*

## Starting a New Job

1. Select **Menu**, then **Start Job**.

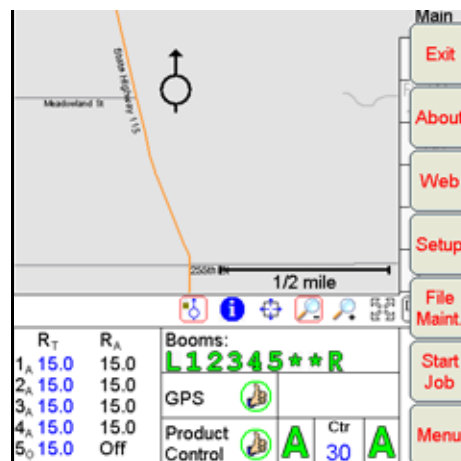

2. Select **New Job**.

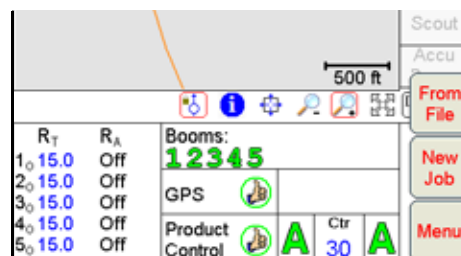



3. The New Job screen displays.

**Note:** If the AccuBoom control feature option (shown above) shows 'No Node' beside it, you do not have a Program D or later boom/speed node. A Program D or later boom/speed node is required to use AccuBoom™ control.

4. Using the screen keyboard, enter a name for the job in the Job Name field. If no name is entered, the date and time are used for the job name.
5. Select the desired options from the list. If no additional features will be used with the Job, touch the **OK** button to open the selected Job file. To setup additional features, select the features to be used and touch the **Next** button.
6. If Swath Guidance was selected, the Select Swath Pattern screen displays.

7. Select a swath pattern from the list and press **Next**. The AccuBoom Setup screen displays if AccuBoom control was selected in the New Job screen.

8. AccuBoom provides several methods of operation. Select the desired option from this screen:
  - **Standard AccuBoom** - This method requires no action or additional setup by the operator. The operator simply begins to apply product to the field and the Viper Pro Console monitors the application and turns boom sections off if they enter into a previously applied area.
  - **Create AccuBoom No-Spray Map** - This method allows the operator to define spray/no-spray zones within the field. This method is typically used if no previous map has been created and the operator wants to define the field boundaries and other boundaries such as waterways, well heads, etc.



- **Load AccuBoom No-Spray Map** - This method allows the operator to load a map that has been previously generated. The operator is given a list of all maps available and allowed to select the desired map.
- **Create Map From Field Boundary** - This method allows the operator to select an existing field boundary and generate a no-spray boundary map from the field boundary map. The operator is given a list of all scout files available and allowed to select the desired map. The boundary must be one previously created by the Viper.

**Note:** See Chapter 7, *Using AccuBoom™*, for details on setting up the AccuBoom feature.

9. Press **Next**. If Product Application was selected, the Product Selection screen displays.



If you are using multiple products, enter the number of products you are applying.

10. If you are using Product Chaining, check Enable Product Chaining.

**Note:** See Chapter 6, *Product Chaining*, to complete Product Chaining setup.

11. Press **Next**. The Product #1 Setup screen displays.

12. Using the screen keyboard, enter a product name in the **Product Name** field.

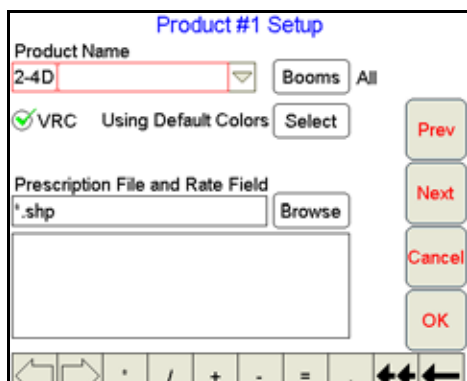

13. Press **Booms**. The Select Booms for this Product screen displays.

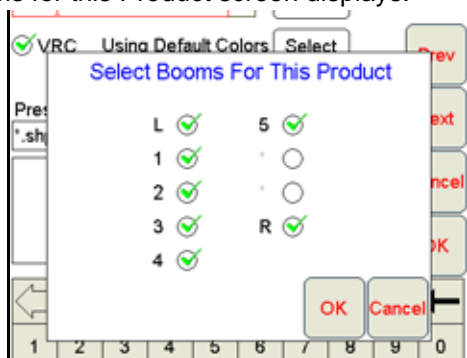

14. Select the booms you want to use to apply the product and press **OK**.

15. To apply a prescription map to the job, check **VRC**.
16. Press **Browse** to display a list of prescription maps.

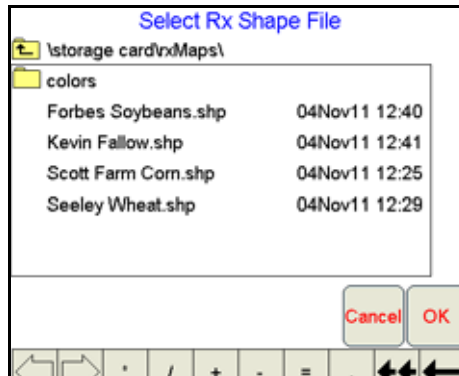

17. Select the appropriate prescription map from the list and press **OK**.

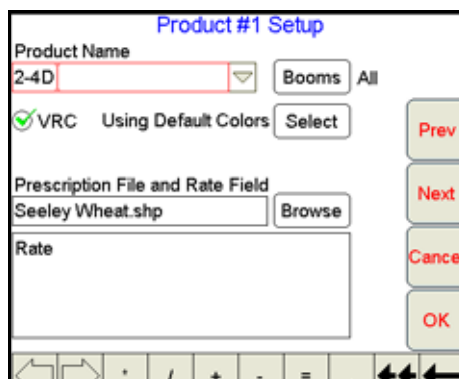

18. Select the appropriate rate information file for rate conversion and press **Next**. The Rate Conversion screen displays.

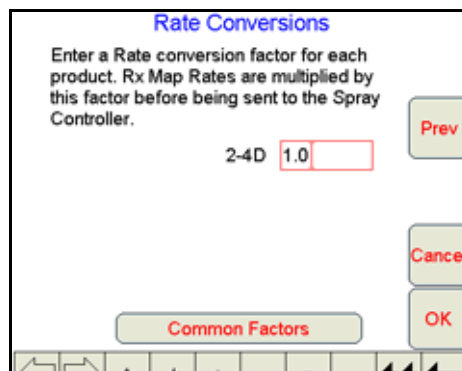

Rate Conversions may be used to calibrate the prescription map for the application. For example, a value of '2' may be used to double the prescription rates on the selected prescription map.

**Note:** *The Rate Conversion value must be greater than zero. In most applications, the conversion factor will be left at the default setting of 1.0*

The Rate Conversions may also be used to convert a prescription map from liters or ounces to gallons, or gallons to ounces or liters. Press the **Common Factors** button to view some common rate conversion values.

19. Enter a conversion factor in the Rate field and press **OK**. Viper loads the new job information into the console.

### Pausing a Job

Select **Menu**, then **Pause Job**. Viper pauses the job.

### Restarting a Paused Job

Select **Menu**, then **Cont Job**. Viper restarts the paused job.

### Existing Jobs

When you open an existing job, you have two options for that job. You can:

- View the existing job
- Add to the existing job

### Viewing an Existing Job

When you view an existing job, you cannot add to the job. You would typically use this feature to view information for a saved job.

1. Press **Menu**, then **Start Job, From File**, and **View Only**. The Select Existing Job File screen opens.
2. Select a job from the list and press **OK**. Viper opens the job.
3. Press **Menu, Close Job** to close the job when you are finished viewing it.

### Adding to an Existing Job

You can use the Viper console to add information to a job that was previously started. You can use this feature if you closed the job before completion because of a change in weather conditions, lack of materials, etc.

**Note:** *When re-opening an existing job, Viper will automatically go into Paused Mode. You must un-pause the job before attempting to add to it.*

When you add to an existing job, the original data is used. Make sure that if you are adding to an existing job, the files used by and created in the existing job are still present on Viper Pro internal memory.

If you are adding to an existing job, make sure that the Viper setup parameters are the same as when the job was originally started. These parameters include number of booms, boom widths, boom offsets, etc.

**Note:** *If you used the Viper Guidance feature for an existing job, the original swathing pattern is used when you add to the job. Due to shifts in satellite geometry between the time the job was originally started and when it was reopened, you should perform a Swath re-calibration to update the swathing pattern information.*

1. Select **Menu**, then **Start Job, From File**, and **Add to Job**. The Select Existing Job File screen displays.
2. Select the job you want to open from the list and press **OK**. Viper loads the job information.
3. Press **Cont. Job** to add to the job.

## Tiered Booms

**Note:** A specialized relay box and cabling is required for operating a tiered boom system.

The Tiered Boom feature of Viper Pro allows the machine to operate over a wider range of application rates than a normal single boom operation. A tiered boom system has two tiers of boom sections stacked on top of each other. Each tier of booms is fitted with a set of nozzles which may or may not be different from the other tiers.

The boom tiers are connected to shut-off valves, which are controlled by a CAN single product node. Through the controlled use of individual or both boom tiers, a much wider range of product control is provided. A low application rate can be applied by turning on the first tier booms. Higher application rates can also be applied by switching to the second tier booms that have larger volume nozzles and an even higher application rate can be achieved by switching on both boom tiers.

The spray tips used on a tiered boom system must be extended range tips. In addition, the volume per minute of the second tier tips should not exceed 1.5 times the volume of the first boom's tips. The tier switching points should be set to 80% of the full flow volume for the boom tier tips.

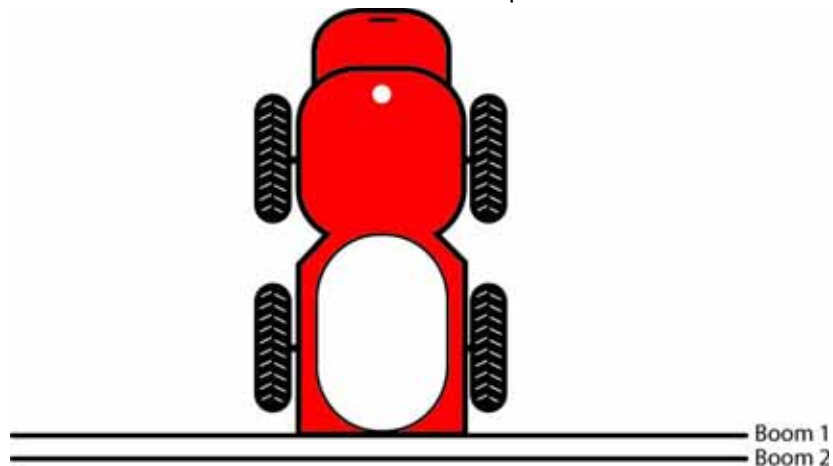

### For Example:

- Maximum Volume Per Minute Tier 1 = 25 gpm
- Maximum Volume Per Minute Tier 2 = 38 gpm
- Tier 1 switch point = 25 gpm x 0.8 = 20 gpm
- Tier 2 switch point = 38 gpm x 0.8 = 30 gpm

A % tier disable is also provided. The % tier disable sets the percent of overlap of the spray volume as the volume per minute required decreases. Thus, if the % tier disable is set to 10% and the tier 2 switch point is set at 30 gpm, then tier 1 and 2 will switch to tier 2 only when the desired volume decreases to 27 gpm.

$$30 \text{ gpm} - (10\% \text{ of } 30 \text{ gpm}) = 30 \text{ gpm} - 3 \text{ gpm} = 27 \text{ gpm}$$

In operation, as the volume per minute increases, the following boom tier switching will occur.

- 10 gpm increasing to 20 gpm tier 1 turned on
- 20 gpm increasing to 30 gpm tier 2 turned on

- 30 gpm increasing to 50 gpm tier 1 and 2 turned on

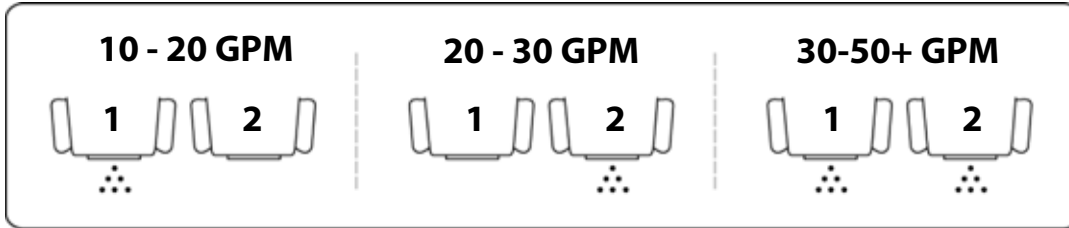

In operation, as the volume per minute decreases, the following boom tier switching will occur.

- 50 gpm decreasing to 27 gpm tier 1 and 2 turned on
- 27 gpm decreasing to 18 gpm tier 2 turned on
- 18 gpm decreasing to 10 gpm tier 1 turned on

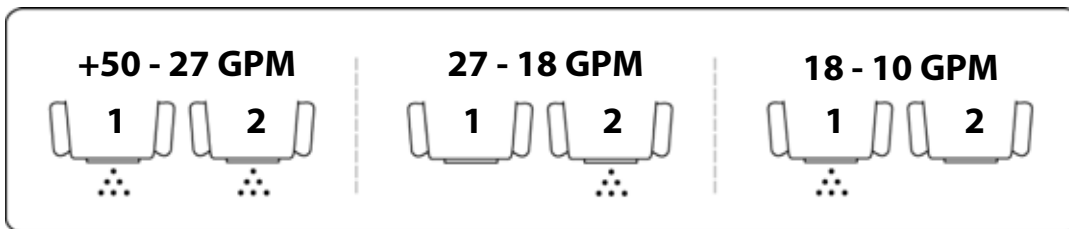

## Enabling Tiered Booms

1. Press the **Product Control area** in the main screen. The CAN Controller Status screen displays.
2. Press **Data Box 2**. The Node 1 Settings screen displays.
3. Press **Next** until the Node 1 Settings screen displays Tier 1 Max, Tier 2 Max, and % Tier Disable.

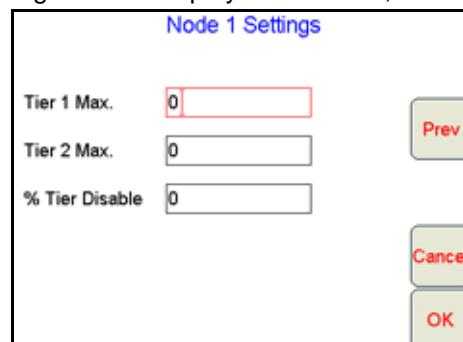

4. Enter your **Tier 1 Max**, **Tier 2 Max**, and **% Tier Disable** values.
5. Press **OK**. Viper saves your settings and returns you to the CAN Controller Status screen.

---

## Application Reports

Reports may be created for viewing and archiving or as a visual report for a customer. Information for the application report may be entered either on the Viper Pro console during the Job or using the Rbin Viewer on a home or office PC.

To enter report information on the Viper Pro console, the information must be entered while the Job is open or in progress. Report information may be entered at any time during an open Job. Previously closed Jobs may be re-opened to edit or complete report information.

Report information may also be edited using the free Rbin Viewer utility. See Chapter 11, *Rbin Viewer*, for more information on downloading and using the Rbin Viewer.

An application report consists of:

- Customer Information
- Field Information
- Field Conditions
- Weather Information
- Applicator Information
- Vehicle Information
- Product Information
- Report Notes

### Customer Information

The Customer Information screen allows you to enter name, address, and customer number information for the application report.

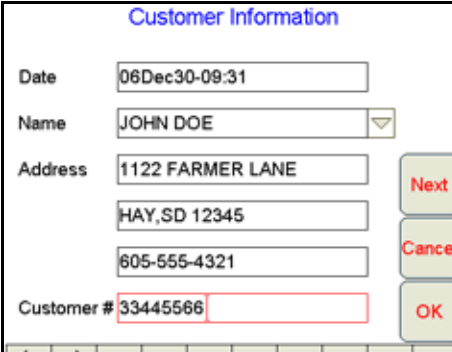

The screenshot shows a 'Customer Information' form with the following fields and values:

Field	Value
Date	06Dec30-09:31
Name	JOHN DOE
Address	1122 FARMER LANE
	HAY, SD 12345
	605-555-4321
Customer #	33445566

Navigation buttons: Next, Cancel, OK.

Once you have added the customer information, you do not have to add the information again if you do another job for the same customer. You can select the customer name from a list and the customer information will be automatically associated with the new job.

## Field Information

The Field Information screen allows you to enter a name for the field, as well as crop type, area, and other information.

The screenshot shows a window titled "Field Information" with the following fields and buttons:

Field Name	WEST 80	
Crop	CORN	Prev
Area	79.7	Next
Section	23-72	Cancel
County	COB	
Township	KERNAL	OK

Once you have added the field information, you do not have to add the information again if you do another job for the same customer. You can select the field name from a list and it is automatically associated with the new job.

## Field Conditions

The Field Conditions screen allows you to enter application type, soil condition, and moisture information for a specific field.

The screenshot shows a window titled "Field Information" with the following fields and buttons:

Application Type	LIQUID	
Soil Conditions	NORMAL	Prev
Moisture	DRY	Next
		Cancel
		OK

Once you have added the field condition information, you do not have to add the information again if you do another job for the same customer. You can select the field condition information from a list for each field on the screen and it is automatically associated with the new job.



## Weather Information

The Weather Information screen allows you to enter wind speed, wind direction, temperature, and humidity levels.

The screenshot shows a form titled "Weather Information" with the following fields and values:

Field	Value
Time Observed	06Dec30-09:31
Wind Speed	7 MPH
Wind Direction	SE
Temperature	78 F
Humidity	67 %

Navigation buttons on the right: Prev, Next, Cancel, OK.

The Watchdog Weather Station is also available for use with the Viper Pro system. See Appendix L, *Weather Station*, for more information and ordering.

## Applicator Information

The Applicator Information screen allows you to enter the operator address and license number.

The screenshot shows a form titled "Applicator Information" with the following fields and values:

Field	Value
Operator	JOE SPRAYS
Address	1122 CHEM ST APPLIER, SD 54322 605-555-0099
License #	12WER8765

Navigation buttons on the right: Prev, Next, Cancel, OK.

Once you have added the applicator information, you do not have to add the information again if you do another job for the same customer. You can select the applicator name from a list and it is automatically associated with the new job.



## Vehicle Information

The Vehicle Information screen allows you to enter the tip size, if applicable.

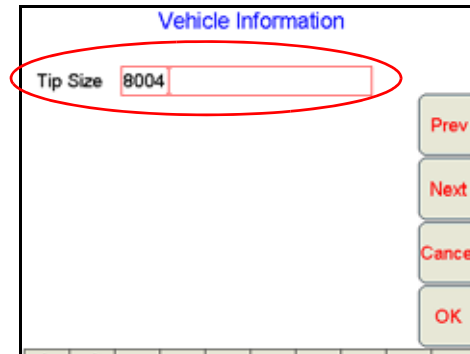

Vehicle Information

Tip Size 8004

Prev

Next

Cancel

OK

## Product Information

The Product Information screen allows you to enter product manufacturer, EPA number, and targeted pests information.

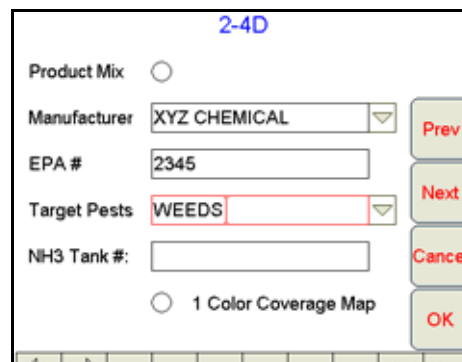

2-4D

Product Mix

Manufacturer XYZ CHEMICAL

EPA # 2345

Target Pests WEEDS

NH3 Tank #:

1 Color Coverage Map

Prev

Next

Cancel

OK

Once you have associated a manufacturer and an EPA number with a product, that information is automatically saved for that product. If you select the product for a future job, the manufacturer and EPA number displays for the product automatically.

If you are applying anhydrous, you can enter the tank number in this screen. The tank number will be displayed on the Rbin report.

You can also select the option of printing the report in a single color instead of the default 3 colors.

## Ingredient Information

If you have checked Product Mix in the Product Information screen, the ingredient information screen will display.

The ingredient information screen allows you to enter the ingredients of a mixed product, which includes the manufacturer, EPA number, target pests, and mixture rate.

**Ingredient 1**

Product Name 2-4D

Manufacturer XYZ CHEMICAL

EPA # 2345

Target Pests WEEDS

Mix Ratio 10%

Next

Cancel

OK

You can enter up to five ingredients for a mixed product. Once you have entered the ingredients you want to include in the report, press **OK**. The view screen displays.

**2-4D**

Product Mix  View

Prev

Next

Cancel

OK

1 Color Coverage Map

You can view the product mix information by pressing the **View** button.

## Report Notes Information

The Report Notes screen allows you to enter any additional notes for the application report.

**Report Notes**

RAVEN EQUIPMENT

BURN DOWN APPLICATION

JOB WENT WELL

Prev

Cancel

OK

## Creating an Application Report

**Note:** *You must be in a job in order to create an application report.*

1. Select **Menu, Report**. The Customer information screen displays. Using the screen keyboard, enter the customer information in each field on the screen.
2. Press **Next**. The Field Information screen displays. Using the screen keyboard, enter the field information in each field on the screen.
3. Press **Next**. The Field Conditions screen displays. Using the screen keyboard, enter the field condition information in each field on the screen.
4. Press **Next**. The Weather Information screen displays. Using the screen keyboard, enter the weather information in each field on the screen.

**Note:** *If the Watch Dog Weather Station is connected to the Viper Pro system, weather information is automatically recorded by touching the **Record** button on the Weather Information screen of the Display Data window.*

5. Press **Next**. The Applicator Information screen displays. Using the screen keyboard, enter the applicator information in each field on the screen.
6. Press **Next**. The Vehicle Information screen displays. Using the screen keyboard, enter the vehicle tip information in the Tip Size field on the screen.
7. Press **Next**. The Product Information screen displays. Using the screen keyboard, enter the product information in each field on the screen.
8. Select **Product Mix** if the product is mixed. If you do not select Product Mix, skip to step 10.
9. Press **Next**. The Ingredient screen displays if you selected Product Mix on the previous screen. Using the screen keyboard, enter the ingredient information in each field on the screen.
10. Press **Next**. The Report Notes screen displays. Using the screen keyboard, enter any report notes in each field on the screen.
11. Press **OK**. Viper saves the information.

**Note:** *To see what the above screens look like, please see the Application Reports section.*

## CHAPTER

# 6

## *Product Chaining*

The product chaining feature allows you to chain together product tanks or bins when applying product to a field. When one tank or bin runs out, Viper automatically switches to another tank and keeps applying product. This reduces trips made by the operator to refill product.

In order to enable product chaining, you must start a new job. You cannot go back and turn on product chaining once you already have a job set up.

**Note:** *The products being chained must have their valve type set up as either 'Fast Close' or 'PWM Close' before enabling product chaining.*

*The Vac/Bin Alarm and Low Tank Alarm must be set up and turned on before beginning product chaining.*

*A tank volume would not have to be set up before starting a job, however, if a node is active, Advance is selected, and the tank volume is zero when the job starts, the product chain will advance right away.*

### Enabling Product Chaining

1. Follow the instructions in the *Starting a New Job* section on page 110.
2. When you get to the Product Selection screen, select the '**Enable Product Chaining**' option. The Product Selection screen allows the user to enter the number of products that will be applied, as well as enable the product chaining option.

**Note:** *If only 1 node is detected, this option will not appear on the screen and the following screens will not be present.*

You must enter two or more products in order to enable product chaining.

The screenshot shows a screen titled "Product Selection" with the question "How many products will you be applying?" and a note "(A value from 1 to 5 is required)". A text input field contains the number "5". Below this, there is a checkbox labeled "Enable Product Chaining" which is checked with a green checkmark. On the right side of the screen, there are four buttons: "Prev", "Next", "Cancel", and "OK". Red circles highlight the input field and the "Enable Product Chaining" checkbox.

3. Click **Next**. The Product Chain Setup screen displays. Select which products you want to chain together and then set the sequence in which the products will be used.
4. Press **Next**.
5. The next Product Chain Setup screen appears, allowing you to set the criteria for how the product will advance. You must select at least one of these options or you will get a setup error.



The screenshot shows a window titled "Product Chain Setup" with a sub-section "Product Advance Settings". It contains three radio button options: "Enable Auto Advance" (checked), "Advance on Bin Level Sensor Alarm" (checked), "Advance on Low Tank Alarm" (unchecked), and "Advance on Tank Volume = 0" (unchecked). On the right side, there are four buttons: "Prev", "Next", "Cancel", and "OK".

**Note:** If 'Enable Auto Advance' is not set, the products WILL NOT advance automatically.

If Advance on Bin Level Sensor Alarm is selected, all products in the chain must have a bin level sensor.

6. Press **Next**.
7. The final Product Chain Setup screen displays. You will need to first setup the chained products and then any non-chained products. You will then be able to finish the rest of the job setup like you would any other job. For more information on product setup and the rest of the job setup, refer to the *Starting a New Job* section on page 110.

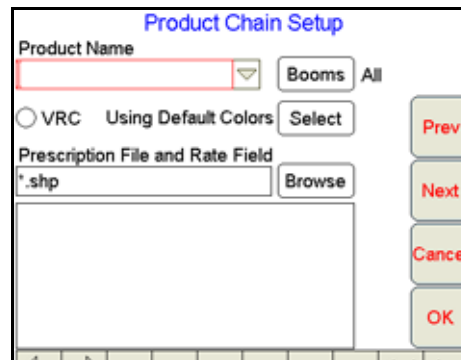

The screenshot shows a window titled "Product Chain Setup" with several input fields and buttons. It includes a "Product Name" field with a dropdown arrow, a "Booms" field set to "All", a radio button for "VRC Using Default Colors" with a "Select" button, a "Prescription File and Rate Field" with a ".shp" entry and a "Browse" button, and a large empty text area. On the right side, there are four buttons: "Prev", "Next", "Cancel", and "OK".

## Using Product Chaining

Once you have product chaining enabled, if it is being used in your job, it will be indicated in the Application Rates screen and by the radio buttons at the top of the screen.

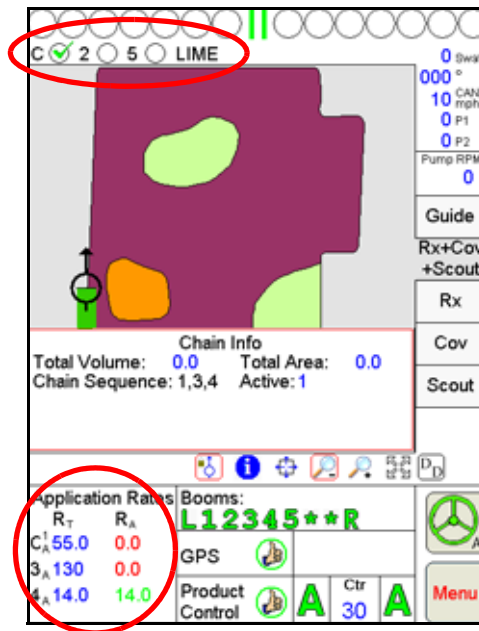

The chain is denoted by the letter 'C'. The super script type indicates the product node in the chain that is currently active. The sub script type indicates the current mode for the active node - 'O' = Off, 'M' = Manual, and 'A' = Automatic. The rate information displayed is for the node that is currently active. The letter 'C' will change color if the 'Enable Auto Advance' option has been selected. If so, the 'C' will be black. If not, the 'C' will be red.

If there are more than 3 lines of data, the 'Application Rates' heading in the Application Rates area will be removed in order to allow the data to display on the Viper Pro screen.

The number radio buttons at the top of the screen do not equal the number of products entered for the job. All chained products are represented by the button labeled 'C.'

If you press the **Application Rates** area, the Application Control screen displays.

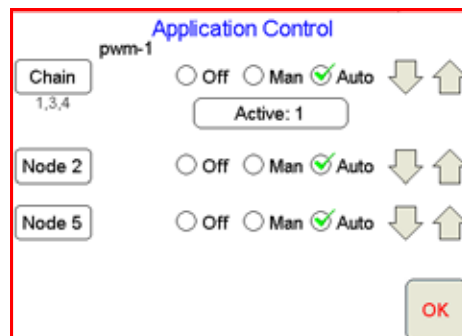

The button labeled 'Chain' is used to access the settings for the node that is listed as 'Active' on the button label. The text under the 'Chain' button lists the sequential order in which nodes were selected for the chain.



If you press the **Active** button, the 'Select Active Chained Product' screen displays.



This screen lists the nodes that were selected to be included in the chain during job setup. The nodes are listed in the order that they will be used if 'Auto Advance' is left on. The settings are global for the product chain and not node specific.

**Note:** If *Advance on Bin Level Sensor Alarm* is selected, all products in the chain must have a bin level sensor.

## Display Data

While you are using the product chaining feature, additional information will be present on the 'Display Data' area. To see this information, press the **Display Data** button and then press in the data area displayed until the required information appears. For more information on the Display Data area, see the *Display Data* section on page 67.

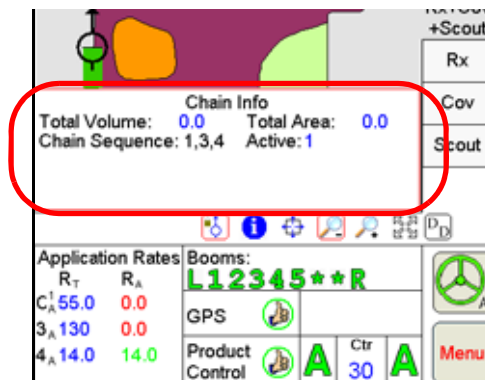

## Miscellaneous Messages

While using the product chaining feature, you will get messages for the alarms or conditions you have set. Below are examples of some of these messages.



The message shown below will display if the Vac/Bin alarm condition is received and the 'Enable Auto Advance' and 'Advance on Vac/Bin' alarm options are selected.



The message shown below will display when the last product in the chain has been emptied and all of the conditions shown in the image above are met.





---

CHAPTER

7

*Using AccuBoom™*



The AccuBoom, automatic boom section control feature, allows the Viper Pro system to automatically control boom sections in reference to coverage or spray/no-spray zone maps. In addition, field boundaries recorded with the AccuBoom feature enabled will automatically set up a no-spray boundary around the target area to help eliminate over spray and wasted chemicals.

When enabled, the AccuBoom feature will automatically turn off an active boom section as it enters an area where product has previously been applied. As the boom section leaves the previously applied area, AccuBoom turns the boom section back on.

The following sections will guide you through setting up and using the AccuBoom feature with the Viper Pro console. Contact your local Raven dealer for more information and available kits for your machine.

FIGURE 1. CAN AccuBoom™ with Viper Pro System Example

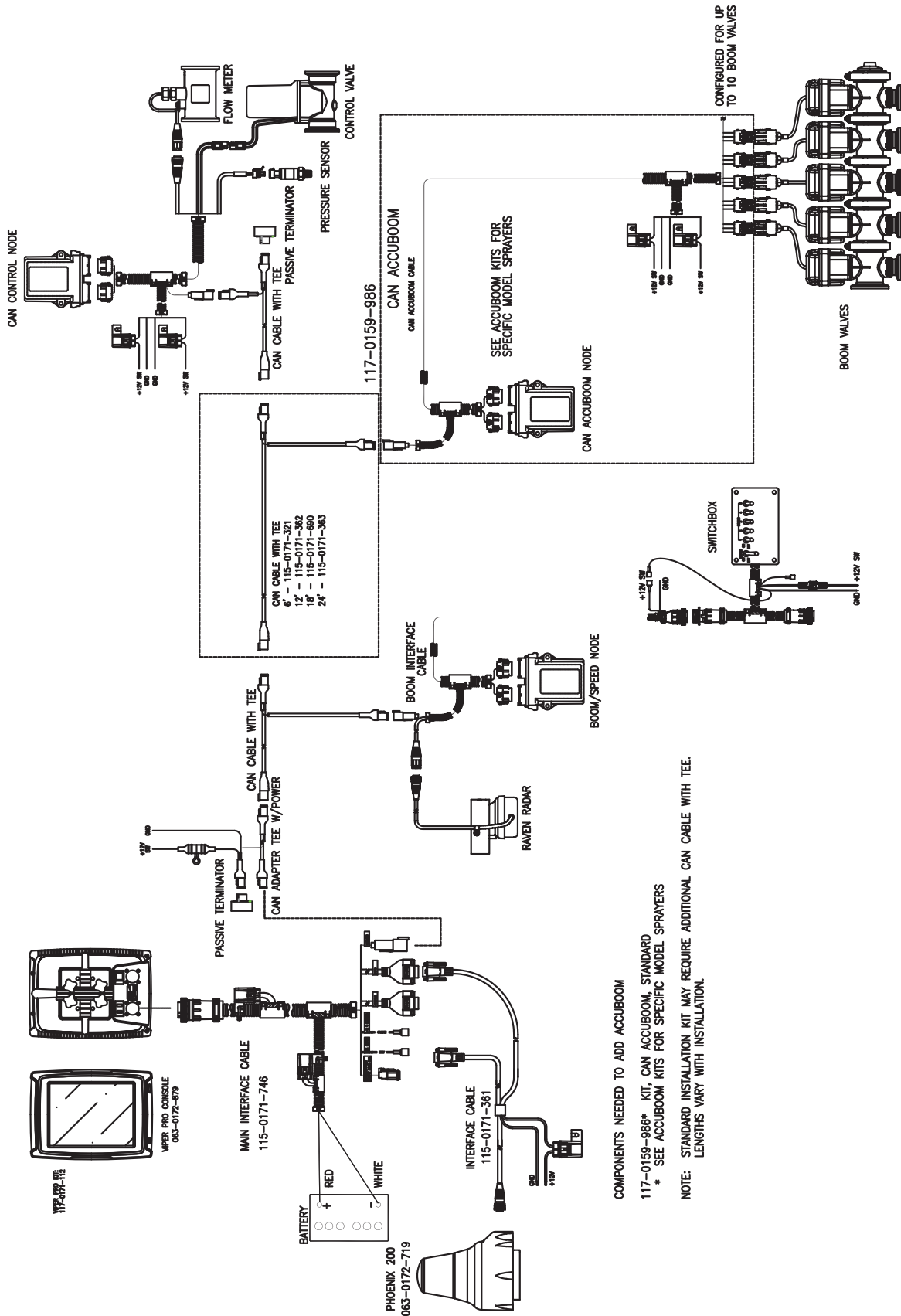



The following screen will be displayed.

AccuBoom Control Setup

Turn-On Look-Ahead Sec: 0.00

Turn-Off Look-Ahead Sec: 0.00

Turn-Off % Coverage: 80

Accuboom Override Sec: 5.00

Enable Zero-Speed Override

Next

Cancel

OK

← → \* / + - = . ← ←

**Note:** In a CAN AccuBoom installation, if you have a boom/speed node installed that is prior to PGM D, the AccuBoom tab will be grayed out and you will receive a warning message.

### Turn-On/Turn Off Look-Ahead

Depending upon the type of valve installed on your machine, control valves may take several seconds to adjust when opening or closing. To help compensate for the valve's response time and lag due to product lines building or relieving pressure, the Look-Ahead values allow the Viper Pro to begin adjusting control valves for spray/no-spray zones and previously applied areas.

**Turn-On Look-Ahead.** Enter the number of seconds ahead of the vehicle (based on vehicle speed) which the Viper Pro will scan for zone boundaries and changes when turning product application on.

**Turn-Off Look-Ahead.** Enter the number of seconds ahead of the vehicle (based on vehicle speed) which the Viper Pro will scan for zone boundaries and changes when turning product application off.

**Note:** The AccuBoom Aggressiveness Factor uses the turn-on and turn-off look-ahead values to adapt the responsiveness of the AccuBoom system for different driving styles and field conditions or layout. See the AccuBoom™ Aggressiveness Factor section on page 134 for more information on using the AccuBoom aggressiveness.

### Turn-Off % Coverage

This value controls the percentage of the boom that must be inside a previously applied area in order for the boom to turn off. The default value is 80%. This would require that 80% of a boom section be in a previously applied area before AccuBoom would turn off that boom section.

**Note:** If the value is set to 0%, the boom will not turn off automatically.

### AccuBoom™ Override Sec

The AccuBoom Override feature allows you to momentarily apply product to a previously applied area while you are in a job. This feature is useful when backing into a corner during boundary spraying or to apply additional product on a heavily infested area of the field.

Enter the number of seconds for AccuBoom to apply product when the AccuBoom Override is selected.

### Enable Zero-Speed Override

Select this option to display the AccuBoom Override button automatically when the machine speed is zero.

## Configuring AccuBoom™ Control

1. Press the **Booms** area in the main Viper screen. The AccuBoom Control Setup screen displays.
2. Using the screen keyboard, enter a value, in seconds, in the '**Turn-On**' **Look-Ahead** field.
3. Using the screen keyboard, enter a value, in seconds, in the '**Turn-Off**' **Look-Ahead** field.
4. Using the screen keyboard, enter a value, in percentage, in the '**Turn-Off**'% **Coverage** field.
5. Using the screen keyboard, enter a value, if desired, in seconds, in the **AccuBoom Override Sec** field.
6. Check the **Enable Zero-Speed Override** if you want the AccuBoom Override button to automatically popup when you stop the machine.

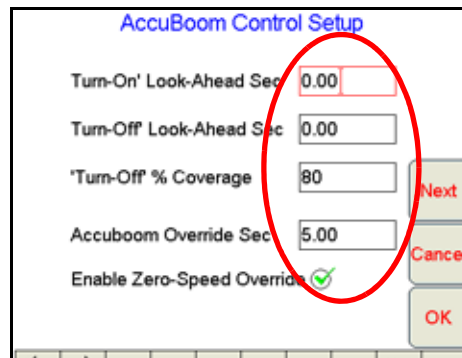

7. Touch the Next button to setup the boom sections which AccuBoom may control automatically.

## AccuBoom™ Boom Disable

The AccuBoom Boom Disable feature allows the operator to select which booms AccuBoom will automatically control.

For example, if a machine has fence row nozzles that will be controlled manually, this feature allows the operator to disable AccuBoom control of these booms.

### Zero Rate Shut Off

Zero Rate Shut Off refers to products for which an Rx Map is used. If the target rate for an area is zero for all Rx Maps, AccuBoom will shut off any controlled boom section that enters that area.

The Zero Rate Shutoff feature allows you to use AccuBoom to automatically turn off product control in areas of an Rx map that has zero rate zones. This is particularly useful for spreader applications. By setting the belt valve setting to PWM Close or Fast Close, AccuBoom will automatically turn off the belt when a zero rate zone is entered. In addition, for a liquid machine, AccuBoom will automatically shut off any boom section that has all Rx map products listing a zero rate zone.

### Disabling Booms and Enabling Zero Rate Zone Shut Off

1. Press the boom area on the main screen.
2. From the AccuBoom Control Setup screen, press **Next**. The AccuBoom Control Setup screen displays.
3. Select the **Enable** option to allow AccuBoom control for selected boom sections or select the **Disable** option to disable the AccuBoom feature.

- Un-check the booms that you want to disable from the AccuBoom function by pressing on the boom number.

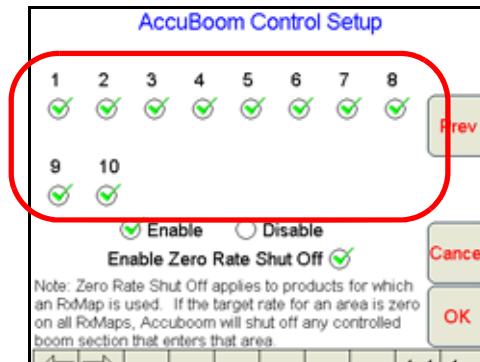

**Note:** AccuBoom will only control boom sections which have a check mark.

- Check **Enable Zero Rate Shut Off** to enable this feature.
- Press **OK**. Viper saves the changes.

## AccuBoom™ Aggressiveness Factor

The look-ahead values set the amount of time ahead of the vehicle (based on vehicle speed) which the Viper Pro will scan for zone boundaries or unapplied areas when turning boom sections on or off. By default, AccuBoom overrides any additional zone boundaries detected until the look-ahead time has passed. For example, if the turn-on look-ahead value is set to 5 seconds and AccuBoom detects an unapplied area 5 seconds ahead of a boom section, AccuBoom toggles that section on and will ignore subsequent commands to turn that section off until the section has entered the unapplied area.

For sections at the end of larger booms or where sharp turns or aggressive maneuvering is necessary, this override may cause unexpected skips in coverage. The aggressiveness factor uses the user defined look-ahead values to adjust AccuBoom response for these driving styles and/or field areas requiring aggressive maneuvering when crossing spray zones.

The AccuBoom aggressiveness factor adds a percentage of the current turn-on or turn-off look-ahead setting to the time which AccuBoom overrides subsequent zone boundaries.

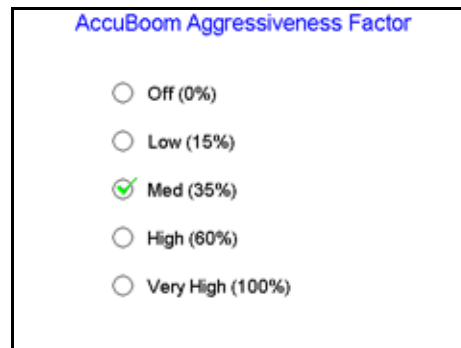

To set the AccuBoom aggressiveness:

- Press the Boom Area on the main screen.
- From the AccuBoom Control Setup screen, press **Next** until the AccuBoom Aggressiveness Factor screen is displayed.
- Select the desired aggressiveness setting to match the operator driving style or requirements.
- Touch **OK** to accept the aggressiveness factor setting and return to the main screen.



## Enabling AccuBoom™ Override

1. While in a job, press the boom area on the main Viper screen. The AccuBoom Control Setup screen displays.
2. Using the screen keyboard, enter a value, in seconds, in the AccuBoom Override Sec field.

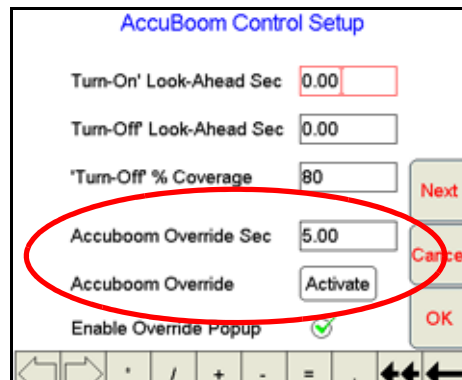

**Note:** If you have previously entered a value for AccuBoom Override, that value will automatically be present in the AccuBoom Override field.

3. Move into the position where you want to spray. Press the **Activate** button.
4. The main screen will re-appear with the AccuBoom Override showing in the boom area and AccuBoom will be overridden for the number of seconds that were entered.

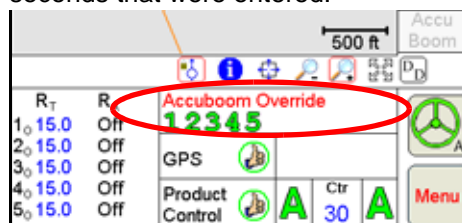

5. Once the set override time has run out, AccuBoom will automatically regain control.

## AccuBoom™ Spray/No-Spray Mapping

AccuBoom can be set up to operate based on a variety of different map features that define spray and no-spray zones. The AccuBoom Setup screen allows the operator to select the desired method of operation for AccuBoom.

The following methods are available for setting up or creating an AccuBoom map:

- Standard AccuBoom
- Create AccuBoom No-Spray Map
- Load AccuBoom No-Spray Map
- Create Map from Field Boundary

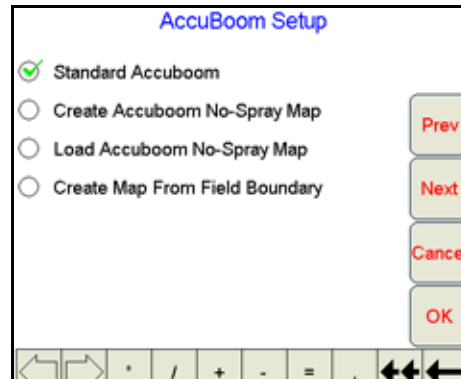

## Standard AccuBoom™ Method

The standard method automatically maps the areas that are sprayed. The booms automatically turn off if they enter into a previously sprayed area. An Rx map may be used to further control the AccuBoom operation in this mode. If an Rx map is used, the Rx map defines field boundaries and no spray zones. The extents of the Rx map define the field boundaries while zero rate zones define areas where AccuBoom automatically turns the booms off. In order for this to happen, 'Enable Zero Rate Shut-Off' must be selected. If zero rate zones are used in multiple Rx maps, they must coincide and be the same in all maps used in the job. If the standard AccuBoom mode is selected, no other setup is required.

## Create AccuBoom™ No-Spray Map Method

This method allows you to define spray and no-spray zones. The spray/no-spray zones can be created while in the scouting operation or while you are applying product to the field. When this method is selected, a new screen prompts you to give the map a name. You also have the option to create a boundary no-spray zone. Selecting the Create No-Spray Boundary option causes the Viper to automatically create a no-spray zone for three boom widths outside the extents of all the spray zones created.

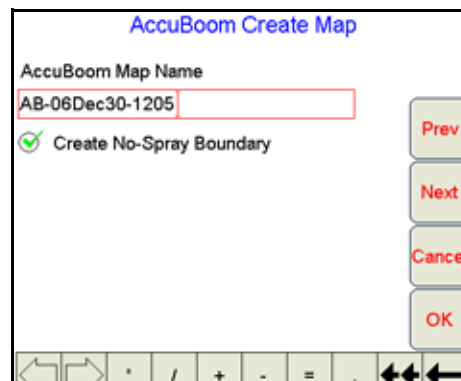

Once the job has been started, AccuBoom will function the same as in the standard AccuBoom mode until all the zones have been defined and the spray/no-spray map is created. After the map has been created, all of the no-spray zones will be masked off. Creating Spray/No Spray maps will be explained later in this section.

**Note:** *If you have selected the manual console operation or an application job is not in process, you will only be able to create a map and the standard AccuBoom functionality will not be available.*

## Load AccuBoom™ No-Spray Map Method

This method allows you to load a map that has already been created. If this method is selected, pressing the Next button will display a screen showing the AccuBoom maps contained in memory. The operator can then select the desired map to load. No further setup is required.

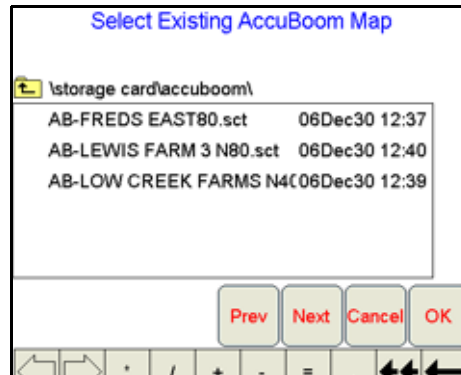

## Create Map From Field Boundary Method

This method allows the operator to select an existing field boundary to use in creating a no-spray field boundary. When the Next button is pressed, a new screen is displayed showing the names of the fields stored on the Viper internal memory.

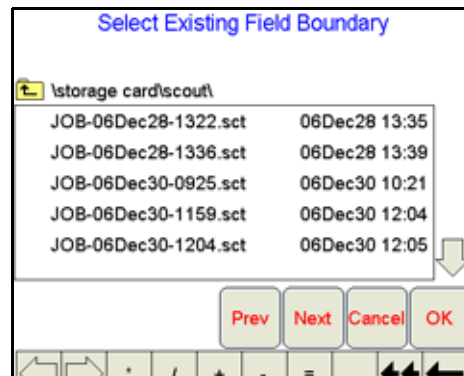

The operator selects the desired field boundary to create a no-spray boundary for the field. A no-spray zone for three booms widths around the extents of the largest zone will be created based on the field boundary file.

**Note:** The file selected must have a completed boundary. If the file selected does not have a completed boundary, a prompt will be displayed indicating that the boundary is not complete. Select another option or another field that contains a completed boundary.

## Changing Spray/No-Spray Default Colors

A set of default colors is provided for the spray and no-spray zones. You can change the colors used to identify spray and no-spray zones.

1. Select **Menu**.
2. Select **Setup, Maps, and Scout Maps**.

**Note:** The spray and no-spray labels will be grayed out and cannot be changed, but the color can be changed by the operator.

3. Press **Color** next to the spray or no-spray feature name. The Feature Colors screen displays.
4. Press the color you want to assign to the spray or no-spray zone and press **OK**. Viper assigns the color to the zone and returns to the Enter Features Name and Color screen.
5. For other zones, repeat step 3 through 4.
6. Press **OK** when you have finished modifying the colors for the spray and no-spray zones. Viper saves the information and returns you to the Main Screen.

**Note:** Select colors for the spray and no-spray zones that are different from the coverage map colors, as the coverage map will be painted over the AccuBoom map when you are in the AccuBoom tab.

## AccuBoom™ Spray/No-Spray Maps

You can create an AccuBoom spray/no-spray map ahead of time using the scouting function or you can create the map when you start a new job. The first step in creating an AccuBoom spray/no-spray map is to define the spray and no-spray zones within a field. These zones are created in the same method as boundary fields.

**Note:** The spray and no-spray selections will only be available while creating a map.

## How to Create a Spray/No-Spray Map

1. Start a new job.
2. Press the **Scout** tab.
3. Select **Record**, then **Zone**. The Record Field Feature screen displays.
4. Select **Spray** or **No-Spray**.

Record Field Feature

Field Boundary  
Spray Zone/Boundary  
Spray  
No-Spray

Manual Point Entry  
 Auto Point Entry  
 Manual Point Entry: Rubber banded zone

Shift 1/2 swath width  Left  Right  
 Do Not Shift

OK  
Cancel

**Note:** Only one zone type can be created at a time.

5. Select an offset shift for the boundary that is in relationship to one-half the boom width.
6. Press **OK**. Viper draws the boundary line on the Scout map as you drive around the boundary.
7. To close the boundary, press **Finish**.

**Note:** Spray/no-spray zones do not have the auto close feature. You will need to select Finish and the Zone to finish at the end of the boundary.

8. To define additional spray/no-spray zones, repeat step 3 through 7 for each spray or no-spray boundary you want to define.

Once a zone is created, it can be viewed on the Scout tab and on the AccuBoom tab. The AccuBoom tab will show all finished zones as well as allow you to create the finished AccuBoom spray/no-spray map when all zones have been defined.

**Note:** Any area not defined will default to a spray zone. However, if the create boundary selection has been checked, it is important to create the outer boundary of the field as a spray zone.

*If you have previously selected to use an existing field boundary, the selected field boundary will be automatically created as a spray zone. The create boundary selection will automatically be displayed and you will be able to create additional zones if desired.*

Once you have created all the spray and no spray zones desired for the job, you are ready to start the AccuBoom spray/no-spray map:

9. On the main screen, select the AccuBoom tab.
10. Press the **Create Map** button.

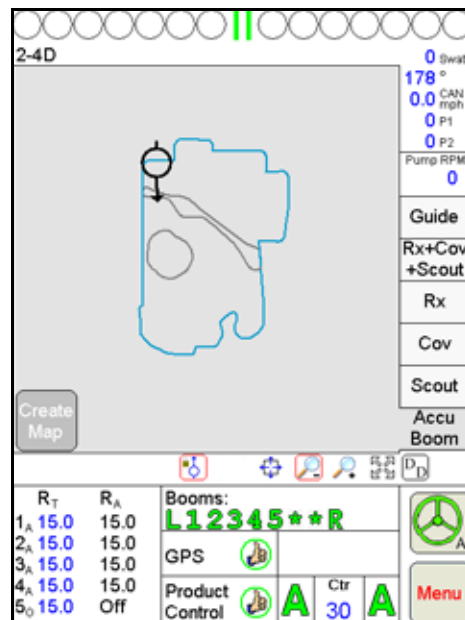

The spray and no-spray zones previously created will be converted to an AccuBoom spray/no-spray zone map. The previously created spray and no-spray zones will be removed from the Scout tab and will appear as

an AccuBoom spray/no-spray map. This map is now available by selecting the AccuBoom tab. The zones will be colored according to their type and the default colors previously selected for spray and no-spray zones.

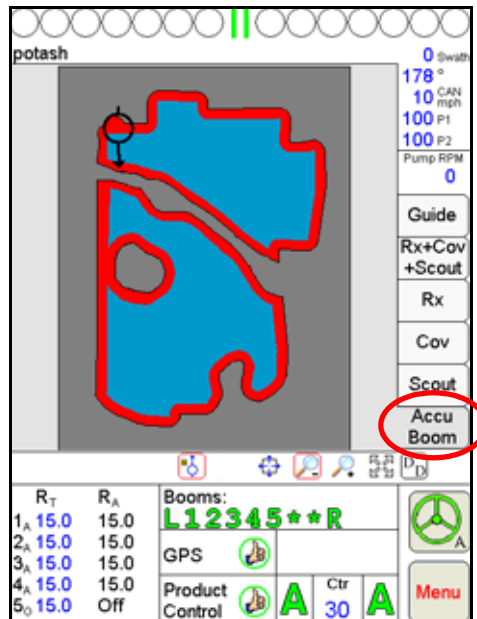

**Note:** The Create Map button will only appear when at least one zone has been defined and when there are no zones in the process of being defined.

CHAPTER

8

Using AutoBoom™

The AutoBoom feature, used in conjunction with Viper Pro, adjusts the height of your booms automatically. Using your boom's hydraulics, AutoBoom's parallel hydraulic system always keeps the hydraulic valves open, gently balancing the hydraulic cylinders and allowing the booms to descend or elevate effortlessly.

There are two AutoBoom systems that can be controlled by Viper Pro:

PowerGlide Plus AutoBoom utilizes gauge wheels to maintain optimum boom height while state-of-the-art hydraulics are used to maintain constant hydraulic pressure in the lift cylinders. PowerGlide Plus systems are typically used in pre-emergent applications.

UltraGlide AutoBoom uses state-of-the-art ultrasonic sensors, instead of the gauge wheels, to gauge the distance to the ground. UltraGlide systems can be used in both pre and post emergent applications.



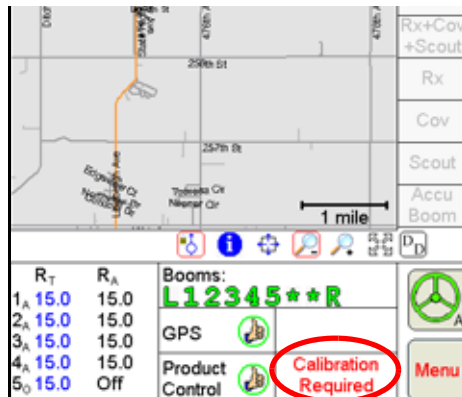

**Note:** Terrain conditions and the machine's hydraulic system will dictate the actual speeds that can be achieved. Typically, rougher and more varied field terrain require slower AutoBoom application speeds.

'Calibration Required' will display in the AutoBoom area of the main screen when AutoBoom is initially installed.

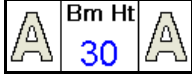
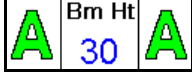

## AutoBoom™ Status Display

The current status of AutoBoom can be determined by viewing the AutoBoom area on the Viper main screen.

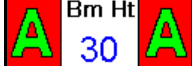
	AutoBoom is detected but is not calibrated. You must calibrate AutoBoom before you can use it.
	AutoBoom is detected and calibrated, but currently turned off. Turn on AutoBoom to use.
	AutoBoom was detected but communication has been lost. Troubleshoot AutoBoom
	AutoBoom is detected and on, but is not enabled. Press the two A's to enable AutoBoom.
	AutoBoom is detected and in operation. No errors are detected in the operation.
	AutoBoom is detected and on but is not enabled. Alarm conditions have occurred on both booms. Troubleshoot.
	AutoBoom is detected and on and is enabled. Alarm conditions have occurred on both booms. Troubleshoot.

**Note:** *If a center ultrasonic sensor is installed, Ctr Ht is displayed in the AutoBoom area in place of the set height.*

Refer to the CAN AutoBoom Calibration & Operation Manual (P/N 016-0130-062) for detailed instructions on calibrating and operating either the UltraGlide or PowerGlide Plus AutoBoom systems with your Viper Pro console.



---

CHAPTER

9

*Viper Pro Guidance*

---

To use the Guidance feature you must have a DGPS receiver such as the receivers listed below. To purchase a DGPS receiver, contact your distributor.

Part Description	Raven Part Number
Invicta 115 Smart Antenna <sup>a</sup>	117-0159-843
Invicta 210 w/Antenna	117-0159-745
Invicta 310 w/Antenna <sup>a</sup>	117-0159-744
Phoenix 200 Smart Antenna	117-0171-071
Phoenix 300 with Antenna	117-0171-097

a. Receiver supported by Viper Pro console but no longer available from Raven Industries.

On the following pages you will see examples of different DGPS receivers connected into the Viper Pro system.

FIGURE 1. Phoenix 300 DGPS Receiver and Antenna with Viper Pro System Example

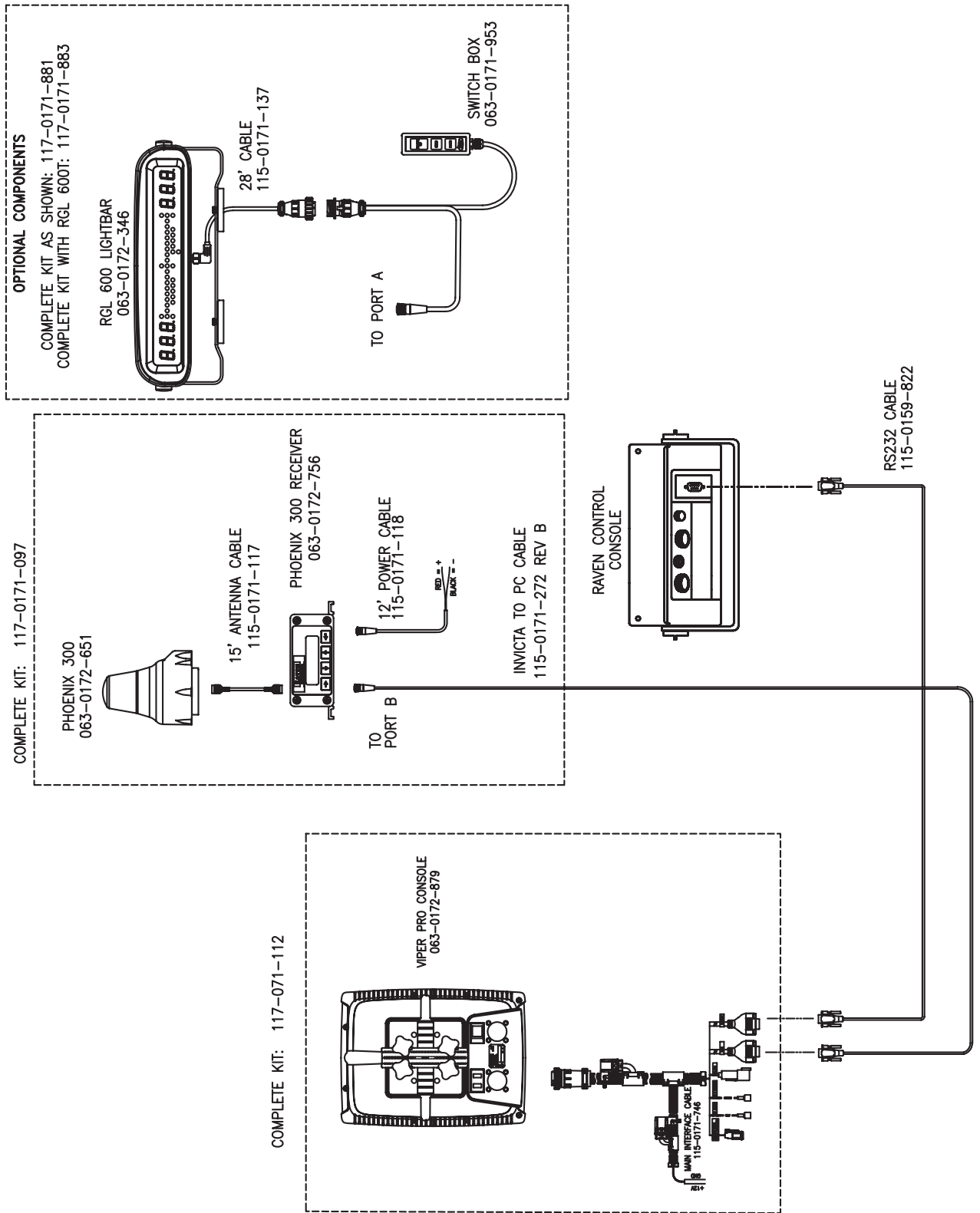
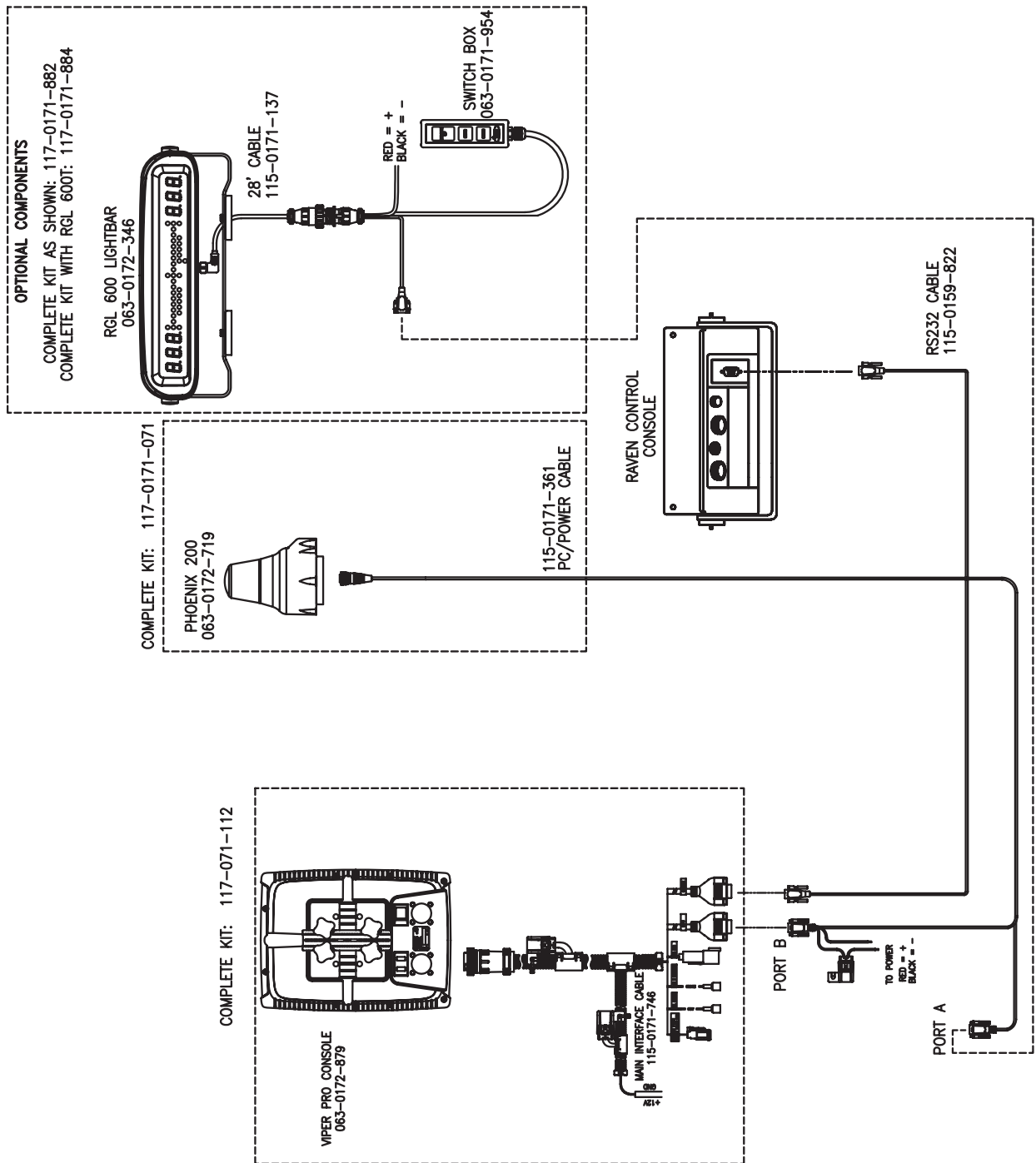

FIGURE 2. Phoenix 200 DGPS Smart Antenna with Viper Pro System Example



## Guidance Views

The Viper Pro provides two viewing options for guidance control, the '**Down Field View**' and the '**Bird's Eye View**'.

The '**Down Field View**' shows a three dimensional display of the field much like the view you would see as viewed from the window of the vehicle.

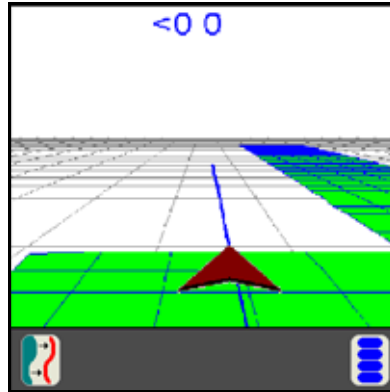

The '**Bird's Eye View**' shows the field and the vehicle as viewed from a distance above.

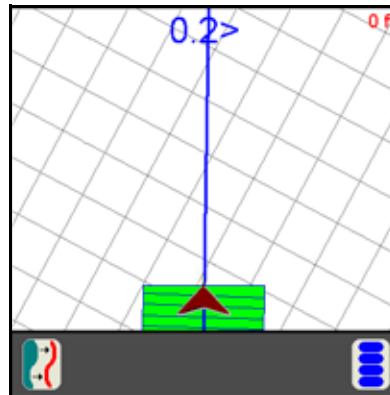

All guidance features can be used in either the '**Down Field View**' or the '**Bird's Eye View**'.

# Swathing Patterns

After you have selected guidance while starting a job, you must select a swathing pattern for your job.

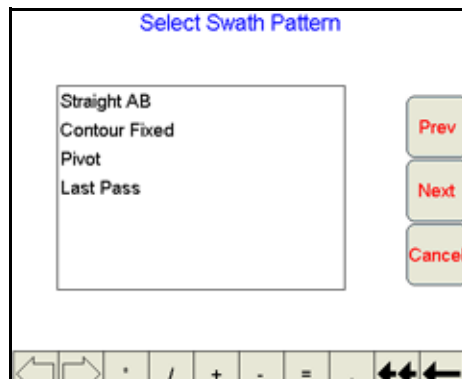

The following swath patterns are available.

Pattern	Description
Straight A-B	A straight A-B line pattern for parallel guidance.
Pivot	A 360 degree (or circle) pattern.
Last Pass	Guidance based on the last nearest pass driven.
Fixed Contour	Allows the operator to set an irregular A-B Line for swath guidance.

## Setting the Straight A-B Line Pattern

Once you have started a job, the guidance screen will display. If you have selected the Straight A-B guidance pattern, you will need to perform the following steps.

1. When you are ready to set Point A, touch the **'Set A'** button on the screen.

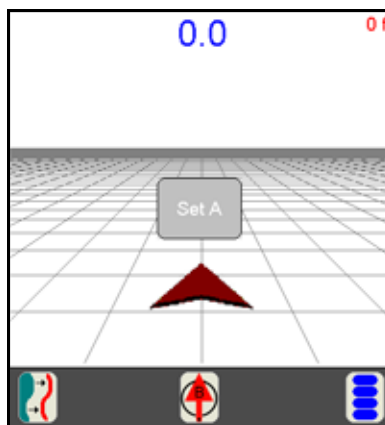

2. Drive to the other end of the straight line you want to drive and press the 'Set B' button on the screen.



Once the B point is set, Viper will create a straight guidance line displayed in blue.

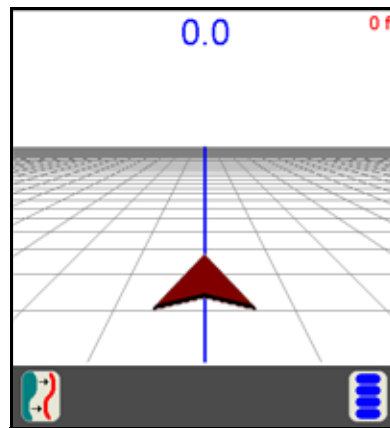

**Note:** While using the Straight A-B Line pattern, the Viper Pro will display the next guidance paths to the right and left of the current swath guidance line.

## Set B by Heading

An A-B Line can also be created by using the Set B by Heading feature. To Set a B point by heading:

1. Touch the 'Set B by Heading' icon along the bottom of the Guidance display.



The A point is set when the 'Set B by Heading' icon is selected. The Set A-B Line By Heading screen will appear.

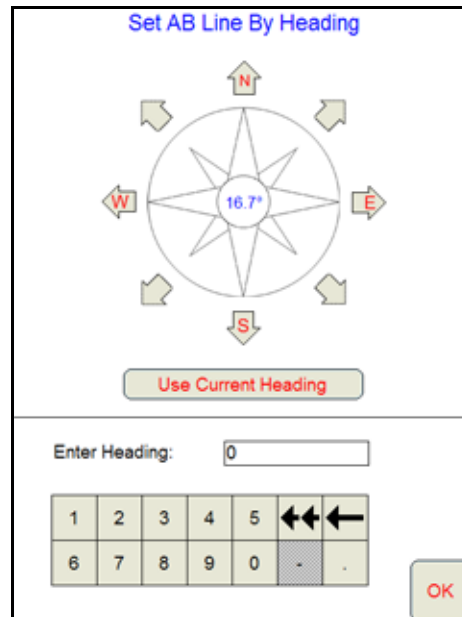

2. Select one of the following to enter the heading for the A-B Line:
  - a. Touch one of the compass heading arrows to set the heading along a compass heading.
  - b. Touch the Use Current Heading button to use the current vehicle heading shown in the center of the compass display.
  - c. Use the on-screen keypad to enter any heading between 0 and 360°.

## Setting the Fixed Contour Pattern

The Fixed Contour pattern allows the operator to set an irregular A-B Line pattern. To set the Fixed Contour Pattern:

1. Touch the '**Set A**' button when you are ready to begin an irregular A-B Line. Viper Pro will begin plotting the vehicle's position as the machine moves along the desired path.
2. Drive the desired path to the end of the swath.
3. At the end of the swath, touch the '**Set B**' button on the screen. Viper will connect the points plotted along the contour and display the driven path with a blue line. Guidance for subsequent swaths will be based on the original contour and the swath number will be displayed in the upper right corner of the screen.

**Note:** *Curvature of the Fixed Contour guidance path should not be too aggressive. Overly aggressive curves may produce undesirable results.*

## Setting the Last Pass Pattern

Once you have started a job, the guidance screen will display. If you have selected the Last Pass guidance pattern, the following screen displays.

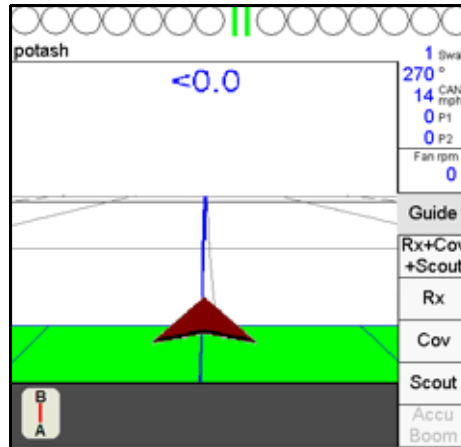

**Note:** Since you have chosen the Last Pass pattern, you will not have to set an A-B line and you can immediately start applying your product.

*Last Pass Guidance is based on the nearest covered area so the booms must be on in order to utilize this guidance pattern.*

When you get to the end of your pass and turn your vehicle, Viper Pro will detect the nearest area that you have covered and use this to determine your guidance for the next swath line.

## Setting the Pivot Pattern

Once you have started a job, the guidance screen will display. If you have selected the Pivot guidance pattern, the following screen displays.

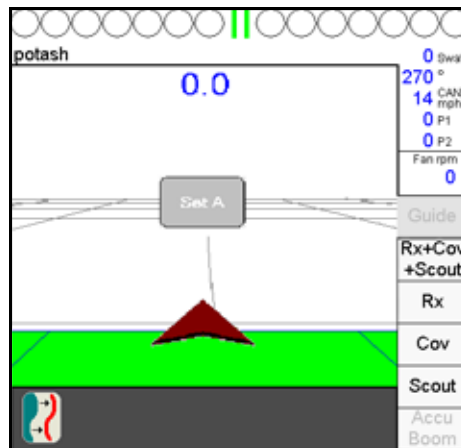



1. Drive to the beginning point of the pivot pattern. When you are ready to set Point A, touch the 'Set A' button on the screen.

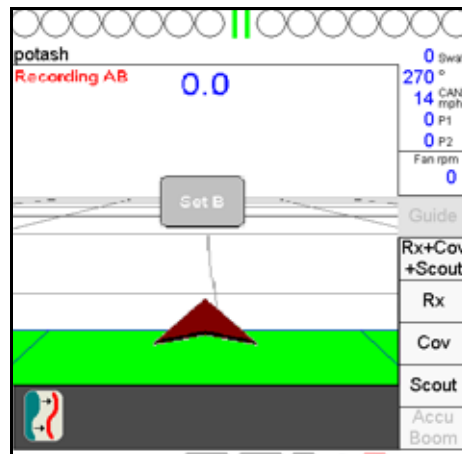

**Note:** Currently, this pattern does not require that a complete pivot pass be driven in order to generate guidance, but the further you drive before setting Point B, the more accurate the guidance will be.

2. Drive along the pivot pattern. When you are ready to set Point B, touch the 'Set B' button on the screen. The guidance lines will now display to the inside of the circle that you just set.

## Using the Guide Tab

Once you have opened a job and selected the Guidance pattern, Viper Pro displays the Guide tab. The map area displays a Course Direction Indicator in the form of an arrow with the arrow pointing in the direction of travel of the vehicle. You can access additional on-screen buttons that allow you to operate the guidance system.

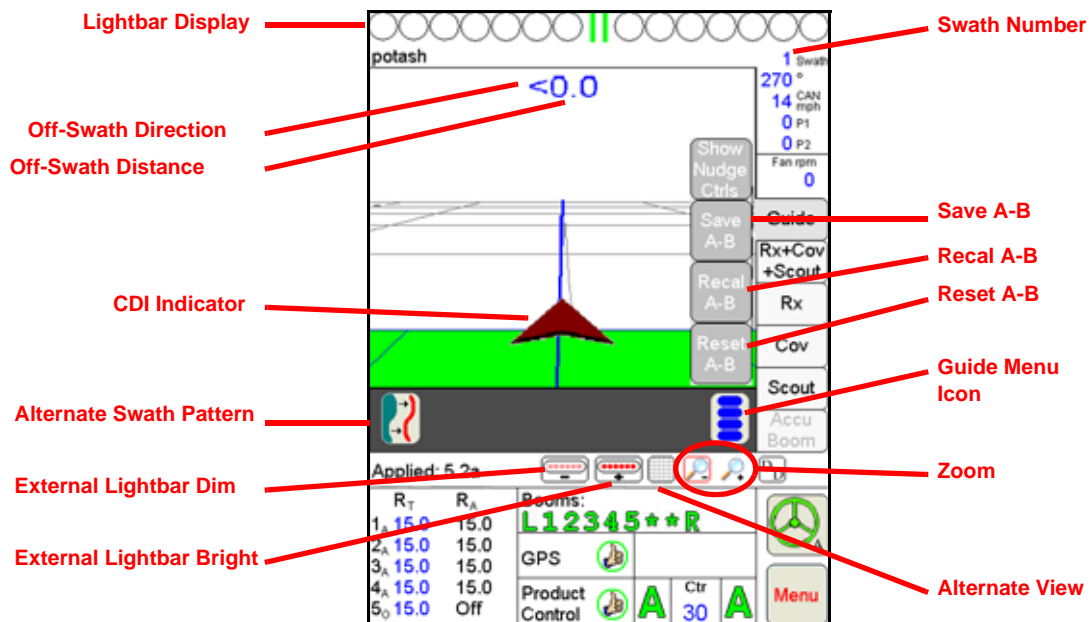

The following features display on the Guide tab:

• Lightbar Display	• Guide Menu Icon	• Course Direction Indicator
• Off-Swath Distance	• LB Bright Button	• Save A-B
• Off-Swath Direction	• LB Dim Button	• Recal A-B
• Swath Number	• Alternate View Button	• Reset A-B
• Alternate Guidance Pattern Button	• Zoom Level	

### Lightbar Display

The on-screen lightbar displays if you have selected that function when setting up the Guidance system. The lightbar displays at all times, regardless of which tab you are using. This allows you to use the Guidance feature at all times.

### Off-Swath Distance

The Off-Swath Distance displays the actual distance the vehicle is away from the swath pattern.

### Off-Swath Direction

The Off-Swath Direction indicator displays the direction that the vehicle is away from the swath pattern. A right arrow indicates that the vehicle is to the right of the swath pattern. A left arrow indicates that the vehicle is to the left of the swath pattern.

### Swath Number

The Swath Number displays the actual number of swath paths completed by the vehicle.

### Alternate Swath Pattern Button

The Alternate Swath Pattern Button displays the alternate guidance pattern that can be selected in the current job.

### LB Bright Button

The LB Bright button displays only if you have configured the Guidance system to use an external lightbar.

Press the LB Bright button to increase the brightness of the external lightbar. The more times you push the button, the brighter the screen will get. Each time you push the LB Bright button, Viper Pro displays the percentage of brightness on the screen to indicate the current intensity level.

### LB Dim Button

The LB Dim button displays only if you have configured the Guidance system to use an external lightbar.

Press the LB Dim button to decrease the brightness of the external lightbar. The more times you push the button, the dimmer the screen will get. Each time you push the LB Dim button, Viper Pro displays the percentage of brightness on the screen to indicate the current intensity level.

## Alternate View Button

The Alternate View button allows you to toggle back and forth from 'Down Field View' to 'Bird's Eye View'. The button shows the alternate view that will be selected when the button is pressed.

## Guide Menu Icon

The Guide Menu icon allows you to access special features available in the guidance pattern you have selected. If the Guide Menu does not show up, then there are no special features available for the guidance pattern selected.

## Zoom Level

The Zoom In and Zoom Out icons allow you to select a view that provides a closer view or a view from a greater distance.

## Vehicle Indicator

The Vehicle Icon provides an indication of where the vehicle is positioned with respect to the overall field. The tip of the arrow represents the antenna position of the vehicle and where it is in reference to the swath line, field, etc.

## Save A-B Button

The Save A-B button allows you to save an A-B line once the line has been set using the Set A and Set B buttons or if the A-B line has been re-calibrated or reset.

## ReCal A-B Button

The Recal A-B button displays if Straight A-B guidance is selected and the menu button is pressed. The Recal A-B button allows you to adjust the A-B line reference for all successive swaths to the new adjusted reference line.









To use this function, you must determine the precise position of where you are in the current swath path and position the vehicle on that point. Once you have positioned the vehicle in the proper position, you can re-calibrate the A-B line to that line reference.

## Reset A-B Button

The Reset A-B button displays if Straight A-B guidance is selected and the menu button is pressed. The Reset A-B button allows you to clear the current A-B guidance points and set new points without closing the current job.

## Screen Icons

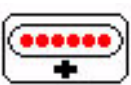
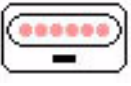
The following screen icons appear on the Guidance screen.

Icon Name	Description
	<b>Guide Menu Icon:</b> Shows the current menu options for the job when you touch the icon.
	<b>Straight A-B Pattern:</b> Allows you to switch to the Straight A-B pattern from the pattern you are presently running by touching the icon.
	<b>Last Pass Pattern:</b> Allows you to switch to the Last Pass pattern from the pattern you are presently running by touching the icon.
	<b>Pivot Pattern:</b> Allows you to switch to the Pivot pattern from the pattern you are presently running by touching the icon.
	<b>Vehicle Icon:</b> The smaller arrow represents the position of the GPS antenna. The large arrow indicates the position of the boom or implement.
	<b>Zoom Out:</b> Allows you to zoom out from the field or area by touching the icon.
	<b>Zoom In:</b> Allows you to zoom in on the field or area by touching the icon.
	<b>LB Increase Brightness:</b> Allows you to increase the brightness level of an external lightbar.
	<b>LB Decrease Brightness:</b> Allows you to decrease the brightness level of an external lightbar.
	<b>Bird's Eye View:</b> Allows you to switch to a 'Bird's Eye View' of the vehicle and the field pattern.
	<b>Down Field View:</b> Allows you to switch to a 'Down Field View' of the vehicle and the field pattern.

## A-B Lines

The straight A-B and fixed contour guidance patterns allow the operator to set a swath guidance based upon the first pass driven. This A-B line can be saved for later use.

**Note:** You can save multiple A-B lines per field. You need to give each line a unique name to distinguish it from the other A-B lines saved.

## Saving an A-B Line

During the job setup, select Straight A-B or Fixed Contour as the swath pattern.

Once the job is started:

1. Press **Set A** to start the first swath path.
2. Drive to the end of the first swath.
3. Press **Set B**. The first swath path is now set.
4. Touch the Guide Menu icon in the guidance screen. The A-B feature buttons will display.

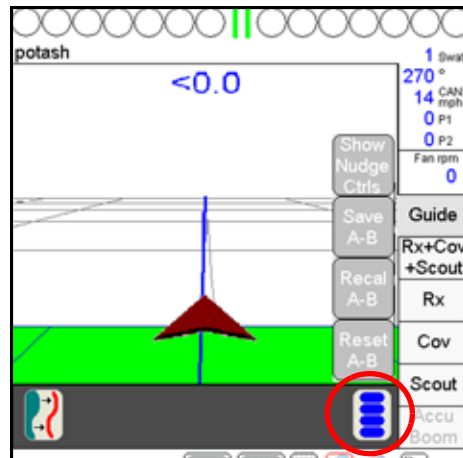

5. Press the **Save A-B** button. The Save A-B Line screen will display.

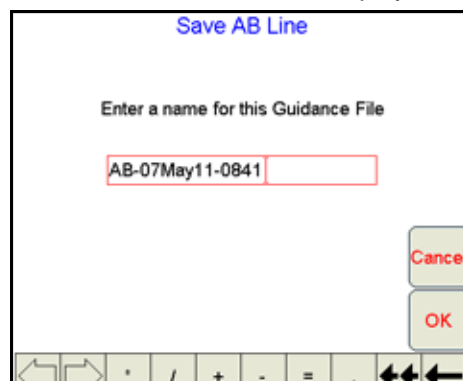

6. Using the screen keyboard, enter a name for the A-B line in the box. If no name is entered, the date and time are used for the A-B line.
7. Press **OK**. The A-B line will be saved and you will be returned to the guidance screen.

**Note:** You should name each A-B line so that it can be easily recognized at a later date. Avoid using dates and times as this will make selecting a previously stored A-B line more difficult.

## Loading an A-B Line

During the job setup, select straight A-B or fixed contour for the swath pattern. Once the job is started:

1. Press the **Guide Menu** icon in the guidance screen.

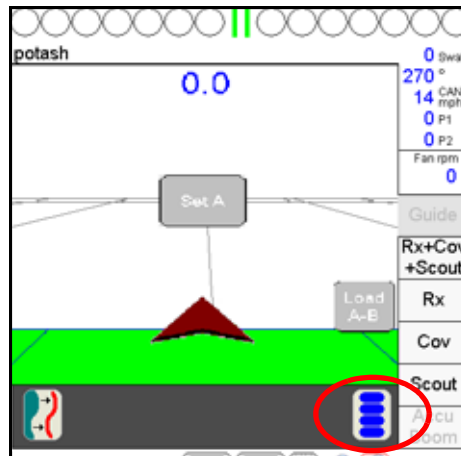

2. Press the **Load A-B** button. The Select A-B Line File screen will display.

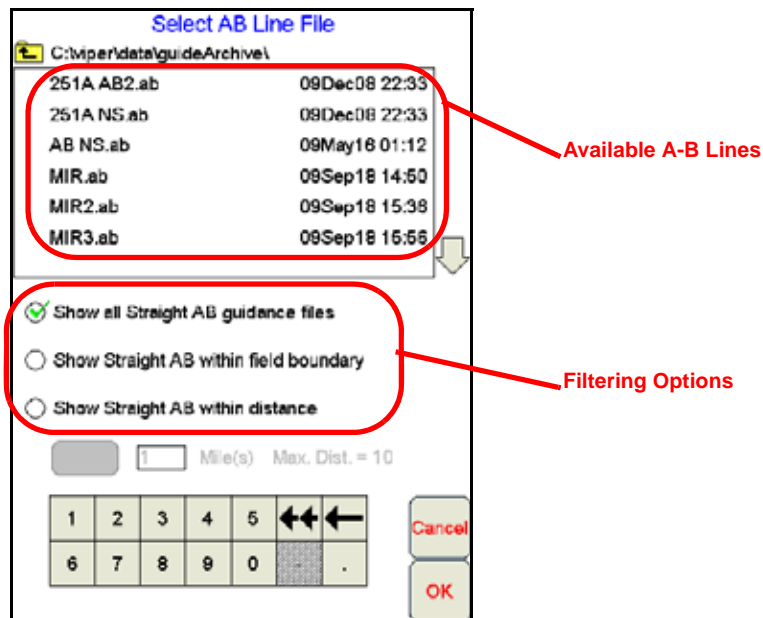

If several A-B lines are saved on the Viper Pro, the following filtering options may be used to help locate a specific guidance path:

**Show all guidance files.** This option shows all currently saved paths of the same type selected when the job was created.

**Show within field boundary.** If a field boundary has been created or loaded into the current job, select this option to view only saved A-B paths within the current boundary.

**Show within distance.** Select the distance filter option to locate an A-B line within a set distance of the current GPS position. The operator may select the distance to use as a filter up to a maximum of 10 miles (straight A-B) or 2 miles (fixed contour). The distance filter is not limited when the pivot pattern is used.

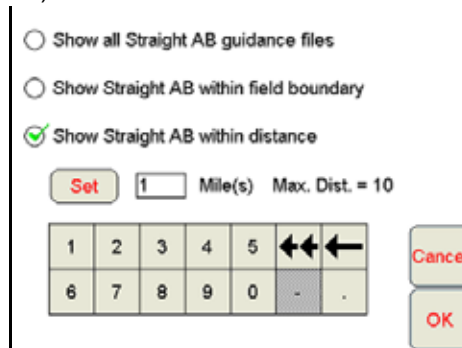

3. Select the desired A-B line from the list provided.
4. Press **OK**. The A-B line will be loaded and you will be returned to the guidance screen.

## Nudge Feature

The Nudge Feature allows the operator to adjust the calculated guidance path to match field conditions. The default Nudge values for a new Profile are 1 inch (centimeter) and 10 inches (centimeters). The user can modify these values for specific machines and implement configurations. The Nudge settings can also be adjusted within a job to modify this feature's characteristics for a particular application.

## Configuring Nudge Settings

### Modifying the Nudge Settings in a Job

A Profile's Nudge settings can be adjusted to match particular requirements of a job.

**Note:** *The in-Job nudge settings will only be accessible with an A-B type guidance path (i.e. Straight Line, Fixed Contour, Pivot).*

To configure the nudge settings in a Job:

1. Touch the Guide Menu icon on the Guidance screen.

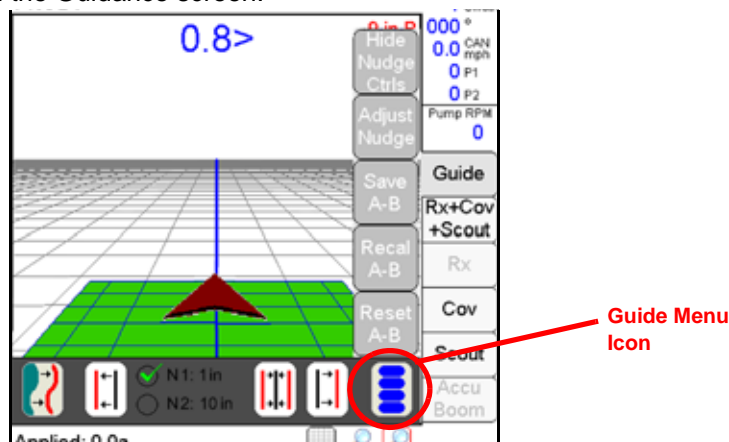

2. Select Adjust Nudge to display the Nudge Settings screen.

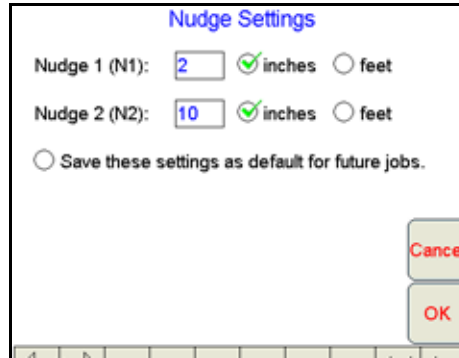

3. Use the on-screen keyboard to enter the nudge value for the Nudge 1 and 2 values.
4. Select the 'inches' or 'feet' option to set the units for the entered nudge value.
5. Select the 'Save these settings as default for future jobs' option to save these nudge values with the Profile. If this option is selected, the nudge values will be available at the start of each Job started on the Viper Pro. If this option is not selected, nudge values must be programmed for each Job.

## Using the Nudge Feature

In order to nudge a guidance pattern, the user must first start a “Swath Guidance” enabled job and set A and B points. Switching to “Last Pass” will cause the nudge controls to be hidden on the Guidance screen.

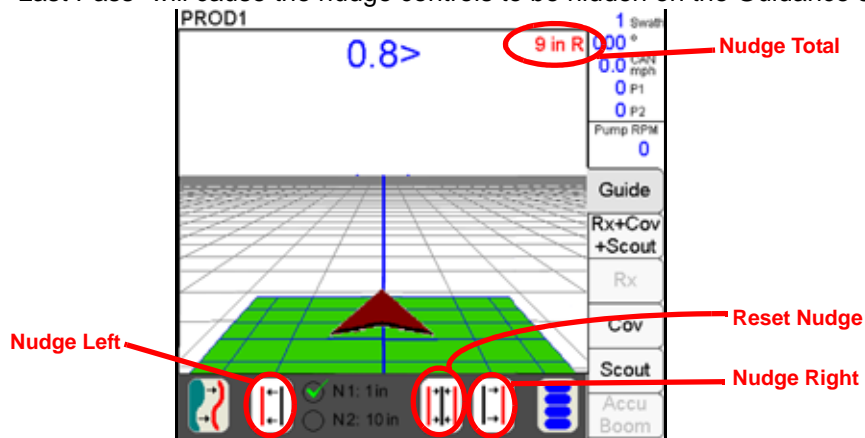

If the Nudge buttons are not available on the Guidance screen, touch the Menu button on the Guidance screen and select Show Nudge Ctrl's. The user will then be able to nudge the swath as desired from the “Guide” tab on the Viper PRO's main screen as shown above.

Two nudge values can be applied by selecting either “N1” or “N2” and then touching the nudge left or right button. The Guidance screen also displays the current total amount a swath pattern has been nudged. When the Reset Nudge button is pressed, the accumulated nudge distance is applied in the opposite direction, effectively removing any nudge adjustment from the current guidance pattern.



---

## *Overview*

File Maintenance can be defined as the process of archiving specific files from the Viper Pro and deleting files that are no longer needed.

It is recommended that the user perform this maintenance at the end of each day. If this is not possible, maintenance should be performed at least once a week.

File maintenance ensures that the Viper Pro system can perform at optimal efficiency by removing files that are no longer needed. Maintenance also safeguards valuable information from being lost in the event that a file is damaged or corrupted, since files will be archived on a personal computer or laptop for future reference.

---

## *File Maintenance*

All Viper Pro job files are stored in memory located inside the Viper Pro. The storage location for these files is of a fixed size and will hold a large, but limited, number of files. File maintenance should be conducted on a regular basis to ensure sufficient storage space is available for your future jobs.

Files can be loaded onto the Viper Pro or downloaded from the Viper Pro using an external USB thumb drive. Insert the USB thumb drive into the USB connector located in the lower left hand corner of the Viper Pro.

**Note:** *Do not leave the USB thumb drive in the front USB connector while you are operating the machine. Insert the USB thumb drive into the front USB connector only to perform file maintenance.*

## Preparing a USB Thumb Drive for File Maintenance

The USB thumb drive must be prepared with the necessary file folders to simplify file maintenance. To populate your thumb drive with the necessary file folders, do the following:

1. Start Viper Pro.
2. Insert a clean formatted USB thumb drive into the front USB port.

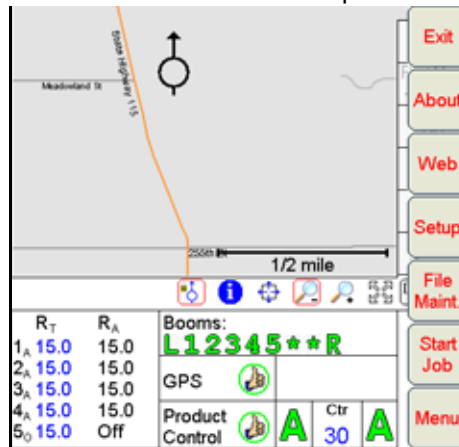

3. Press **Menu**, **File Maint.** The following screen will display.

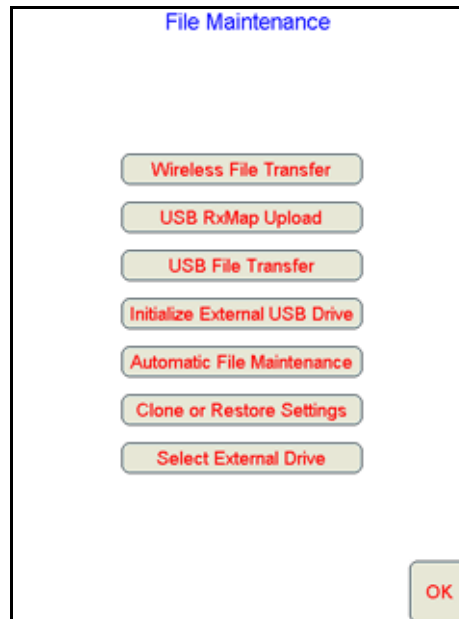

4. Press **Initialize External Storage**. The following screen will display.



5. Press **OK**. The necessary file folders will be loaded onto the thumb drive.  
6. Press **OK** to return to the File Maintenance main menu.

Your USB thumb drive will now be populated with the necessary file folders needed by the Viper Pro.

### Thumb Drive File Structure

Your USB thumb drive will be populated with the following file folder structure. The main two files are the jobs folder and the misc folder. The jobs folder will initially be empty. This folder will contain job related information that you download from the Viper Pro. This misc folder contains those files that are not specifically job related.

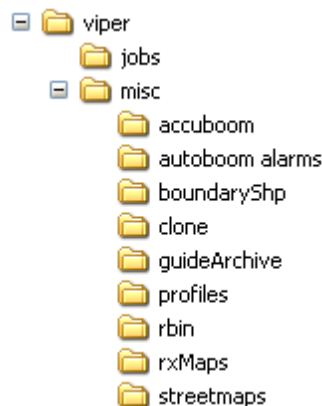

### Misc Folder Sub-folders

The misc folder contains information that is not job specific. Several sub-folders are contained in the misc folder to help organize this information. The following information is contained in the sub-folders.

**AccuBoom Sub-folder:** The AccuBoom sub-folder can be used to upload or download no-spray zone templates that have been set up for specific fields. Once these templates are transferred to the Viper Pro, they can be used when starting a new job in the selected field.

**AutoBoom Alarms Sub-folder:** The AutoBoom Alarms sub-folder can be used to download AutoBoom alarm information. This information will only be available on the Viper Pro if the alarm recording function is enabled in AutoBoom.

**BoundaryShp:** The boundaryShp folder contains any shapefiles for field boundaries created using GIS software and transferred to the Viper Pro console.

**Note:** *Field Boundaries created using the Viper Pro are saved as a part of the Job file.*

**Clone:** The clone sub-folder will only appear on the USB drive if a clone of the Viper Pro has been created. Clones may be used as “restore points” to quickly and easily reset the Viper Pro console to a previous set up. A clone will contain the following files contained within the Viper Pro file structure:

- Coverage Maps
- Prescription Maps
- Streetmaps
- Scout Maps
- A-B Lines
- Job files
- Rbin files
- Boom Configuration
- AccuBoom Configuration
- Comm Port settings

Refer to *Clone or Restore Settings* section on page 168 for instructions on creating or restoring clone files.

**GuideArchive Sub-folder:** The guide Archive sub-folder can be used to transfer A-B guidance lines from one machine to another.

**Profiles Sub-folder:** The profiles sub-folder allows you to load machine profiles that have been set up for different machine configurations.

**Rbin Sub-folder:** The rbin sub-folder allows you to download specific job rbins without downloading the complete job information.

**RxMaps Sub-folder:** The ‘rxMaps’ sub-folder is used to transfer prescription maps to the Viper Pro. These prescription maps must be in the proper shapefile format used by the Viper Pro.

**Streetmaps Sub-folder:** The streetmaps sub-folder can be used to load streetmap shapefiles onto the Viper Pro. The streetmaps must be in the proper shapefile format used by the Viper Pro.

**Note:** *Once the streetmap files are loaded into the Viper, you will still need to install the streetmap into the Viper Pro system memory.*

## Performing File Maintenance

The Viper Pro provides much flexibility in managing and maintaining your files on the Viper Pro.

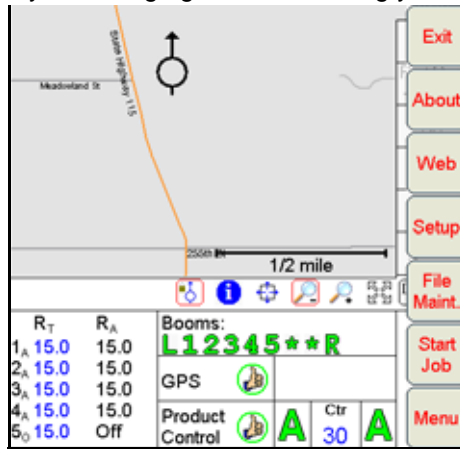

To access the File Maintenance feature:

1. Press **Menu** on the main Viper Pro screen.
2. Select **File Maint.** The following file maintenance options appear.

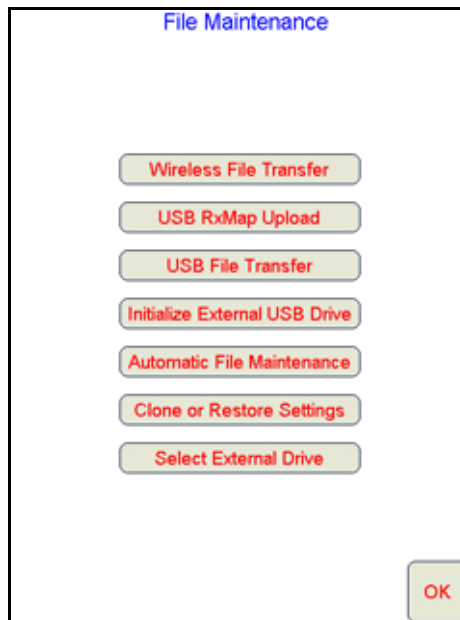

### Wireless File Transfer

The Wireless File Transfer button is displayed only if a Raven Field Hub is connected and communicating with the Viper Pro console. Select this option to setup the desired method for initiating file transfer via a wireless connection.

**Note:** A wireless signal is required to transfer files from the Viper Pro console. If signal is weak or not available, files may not be transferred as expected.



### Automatic

If the “Automatic File Upload at End of Job” option is selected, the Viper Pro will attempt to transfer application files automatically each time a job file is closed.

### Prompt

If the “Prompt Before Upload at End of Job” option is enabled, the operator will be prompted to before the Viper Pro attempts to transfer files.

### Disable

Select the “Disable Wireless File Transfer” to disable sending files from the Viper Pro.

## Uploading Prescription Maps from a USB Thumb Drive

Prescription maps may be uploaded from the USB thumb drive by selecting the USB RxMap Upload button on the File Maintenance screen.

To upload prescription maps:

1. Press **Menu** on the main screen.
2. Select **File Maint.** from the list of menu options.
3. Select **USB RxMap Upload** from the list of file maintenance options. The following warning screen will display.

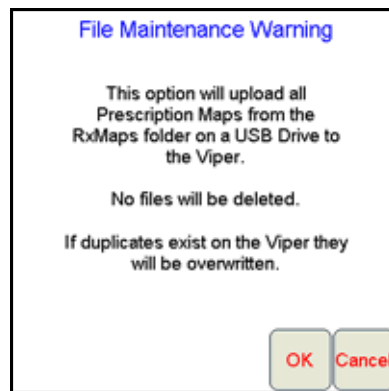

4. Press **OK** to upload the prescription maps from the USB thumb drive to the Viper Pro internal storage or **Cancel** to abort the upload process.

## USB File Transfer and Advanced File Maintenance

The USB File Transfer feature allows the machine operator to select specific files to copy, move or delete from a connected USB drive or internal memory.

To perform advanced file Maintenance:

1. Press **Menu** on the main screen.
2. Select **File Maint.** from the list of menu options.

3. Select **USB File Transfer** from the list of file maintenance options. The Advanced File Maintenance screen will display.

Advanced File Maintenance		
Select file type to work with		
<input type="radio"/> Job	<input type="radio"/> Guidance	<input type="radio"/> Accuboom
<input type="radio"/> RBIN	<input type="radio"/> RxMap	<input type="radio"/> Profile
<input type="radio"/> Street Map	<input type="radio"/> Boundary	<input type="radio"/> All Types

**Note:** Touch the **Reset** button at the bottom of the Advanced File Maintenance screen to clear all selections and begin the advanced file maintenance setup again. Select the **Cancel** button to return to the File Maintenance screen.

### Selecting a File Type to Work With

4. Select the type of file on which to perform file maintenance or transfer via a connected USB drive.

Advanced File Maintenance		
Select file type to work with		
<input checked="" type="radio"/> Job	<input type="radio"/> Guidance	<input type="radio"/> Accuboom
<input type="radio"/> RBIN	<input type="radio"/> RxMap	<input type="radio"/> Profile
<input type="radio"/> Street Map	<input type="radio"/> Boundary	<input type="radio"/> All Types

### Selecting an Operation to Perform

5. Once the type of file is selected, the Select Operation to Perform selection displays. Select:
  - Copy - Makes a copy of the selected file on the destination storage location. Copied file is retained on the source storage location.
  - Delete - Deletes the selected files from the source storage location.
  - Move - Move the file from the source storage location to the destination storage location. The selected file on the source storage location is deleted.

Advanced File Maintenance		
Select file type to work with		
<input checked="" type="radio"/> Job	<input type="radio"/> Guidance	<input type="radio"/> Accuboom
<input type="radio"/> RBIN	<input type="radio"/> RxMap	<input type="radio"/> Profile
<input type="radio"/> Street Map	<input type="radio"/> Boundary	<input type="radio"/> All Types
Select Operation to Perform		
<input type="radio"/> Copy	<input type="radio"/> Delete	<input type="radio"/> Move

### Selecting Source/Destination

6. Select the source location of the files on which the selected operation will be performed. For the Copy and Move operations, the destination is also listed.

Advanced File Maintenance		
Select file type to work with		
<input checked="" type="radio"/> Job	<input type="radio"/> Guidance	<input type="radio"/> Accuboom
<input type="radio"/> RBIN	<input type="radio"/> RxMap	<input type="radio"/> Profile
<input type="radio"/> Street Map	<input type="radio"/> Boundary	<input type="radio"/> All Types
Select Operation to Perform		
<input checked="" type="radio"/> Copy	<input type="radio"/> Delete	<input type="radio"/> Move
Select Source/Destination		
<input checked="" type="radio"/> Viper --> USB Drive	<input type="radio"/> USB Drive --> Viper	

Advanced File Maintenance		
Select file type to work with		
<input checked="" type="radio"/> Job	<input type="radio"/> Guidance	<input type="radio"/> Accuboom
<input type="radio"/> RBIN	<input type="radio"/> RxMap	<input type="radio"/> Profile
<input type="radio"/> Street Map	<input type="radio"/> Boundary	<input type="radio"/> All Types
Select Operation to Perform		
<input type="radio"/> Copy	<input checked="" type="radio"/> Delete	<input type="radio"/> Move
Select Source/Destination		
<input checked="" type="radio"/> From Viper	<input type="radio"/> From USB Drive	



### Selecting Associated File Actions

7. Some file types may be associated with a job file on the Viper Pro. If job files will be deleted, the operator must choose what action to perform on files associated with the job file being deleted.

Advanced File Maintenance		
Select file type to work with		
<input checked="" type="checkbox"/> Job	<input type="checkbox"/> Guidance	<input type="checkbox"/> Accuboom
<input type="checkbox"/> RBIN	<input type="checkbox"/> RxMap	<input type="checkbox"/> Profile
<input type="checkbox"/> Street Map	<input type="checkbox"/> Boundary	<input type="checkbox"/> All Types
Select Operation to Perform		
<input type="checkbox"/> Copy	<input checked="" type="checkbox"/> Delete	<input type="checkbox"/> Move
Select Source/Destination		
<input checked="" type="checkbox"/> From Viper	<input type="checkbox"/> From USB Drive	
Select Associated File Actions		
<input type="checkbox"/> Delete Accuboom File	<input type="checkbox"/> Delete RxMap Files	
<input type="checkbox"/> Delete RBIN File	<input type="checkbox"/> Select All	
<input type="checkbox"/> Prompt		

**Note:** Deleting job files is the only condition which associated file actions must be selected.

### Selecting File Selection Method

- 8. Next, select the method to select specific files.
- By Age - Select the “by Age” option to set an age for files which the action will be performed upon. The operation will be automatically selected and copied, moved, or deleted.
- All - Select the “All” option to perform the selected operation on all files of the selected type.
- Selected - Set the “Selected” option to manually select the files to copy, move, or delete.

Advanced File Maintenance		
Select file type to work with		
<input checked="" type="checkbox"/> Job	<input type="checkbox"/> Guidance	<input type="checkbox"/> Accuboom
<input type="checkbox"/> RBIN	<input type="checkbox"/> RxMap	<input type="checkbox"/> Profile
<input type="checkbox"/> Street Map	<input type="checkbox"/> Boundary	<input type="checkbox"/> All Types
Select Operation to Perform		
<input type="checkbox"/> Copy	<input checked="" type="checkbox"/> Delete	<input type="checkbox"/> Move
Select Source/Destination		
<input checked="" type="checkbox"/> From Viper	<input type="checkbox"/> From USB Drive	
Select Associated File Actions		
<input type="checkbox"/> Delete Accuboom File	<input type="checkbox"/> Delete RxMap Files	
<input type="checkbox"/> Delete RBIN File	<input type="checkbox"/> Select All	
<input type="checkbox"/> Prompt		
Selection Method		
<input type="checkbox"/> Delete by Age	<input checked="" type="checkbox"/> Delete Selected	
<input type="checkbox"/> Delete All		

Next Reset Cancel

9. Finally, touch the **Next** button to begin the file maintenance operation.



If the “Selected” option is selected in step 8, a list of available files will be listed.

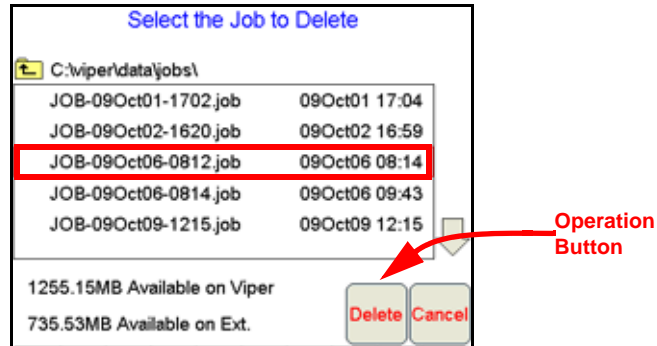

Select a file from the list and touch the operation button to perform the operation on the selected file. Touch the **Cancel** button to return to the Advanced File Maintenance screen.

## Initialize External USB Drive

Select the Initialize External USB Drive and follow the on-screen instructions to setup the required file structure on a connected USB thumb drive.

## Automatic File Maintenance

The automatic file maintenance feature will automatically perform the following steps:

1. Move all Rbin files to the USB drive.
2. Delete all existing job files from Viper Pro internal storage.

**Note:** All field boundaries, saved A-B lines, AccuBoom templates, street and prescription maps will be maintained on the internal storage.

To perform automatic File Maintenance:

1. Press **Menu** on the main screen.
2. Select **File Maint.** from the list of menu options.
3. Select **Automatic File Maintenance** from the list of file maintenance options. The following warning screen will display.



Press **OK** to download the Rbin files from the Viper internal storage and delete associated job files from the Viper Pro or **Cancel** to abort the downloading of Rbin files.



## Clone or Restore Settings

The Clone or Restore Settings feature can be used to save all settings and files from the Viper Pro console to external memory. These clones can then be reloaded to restore settings to the same Viper Pro or transferred to another Viper Pro console.

Touch the **Clone or Restore Settings** button to view the following display.

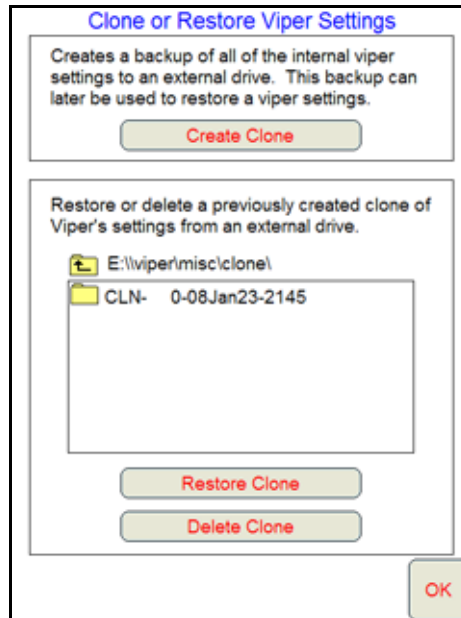

If a clone has previously been created, select the file name from the list and touch Restore Clone to restore the selected clone on the Viper Pro console. To delete a clone, select the file name and touch Delete Clone to remove the selected clone.

Touch the Create Clone button to save the Viper Pro's settings to the selected file. The following screen will be displayed.

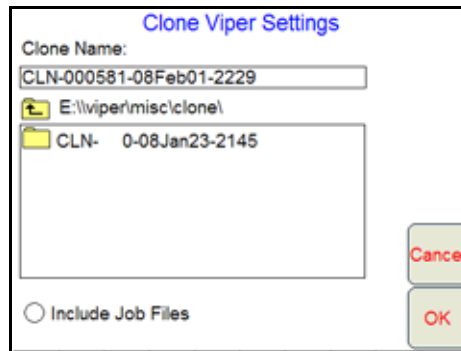

Enter a name for the clone in the Clone Name field along the top of the screen. Select the "Include Job Files" option to include the current Job files located on the Viper Pro's internal memory with the clone. Once finished, touch the OK button to create the clone.

## Select External Drive

If you have more than one flash drive connected to the Viper Pro at one time, the Select External Drive button will be displayed on the File Maintenance screen. Touch this button to select an external drive.

## CHAPTER

# 11

## *Rbin Viewer*

The Rbin Viewer is used on your personal computer to view and print application reports that have been previously created using Viper Pro. You can also use the Rbin to export the application data as a shapefile for use in other software packages.

**Note:** Rbin Viewer version 1.15.1 is required for use with Viper Pro software versions 3.0 or higher.

### *Downloading Rbin Viewer*

You can download the latest version of Rbin Viewer free of charge from the Raven web site at:

<http://www.ravenprecision.com/Support/Software/index2.jsp>

### Downloading Rbin Software

1. Go to the Raven web site. The following screen displays.



2. Locate the available Viper/Viper Pro software updates.



3. Select the latest Viper Pro Rbin Viewer version.
4. Click on **Download Now**. A window similar to the following will appear.

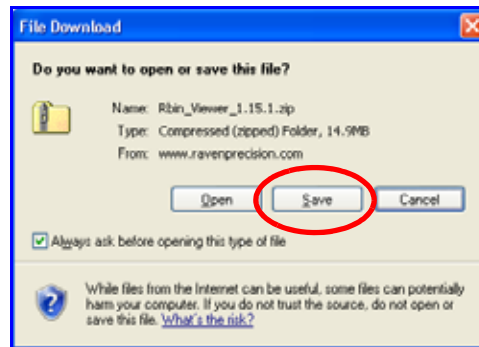

5. Click on **Save**. A screen similar to the following will display.

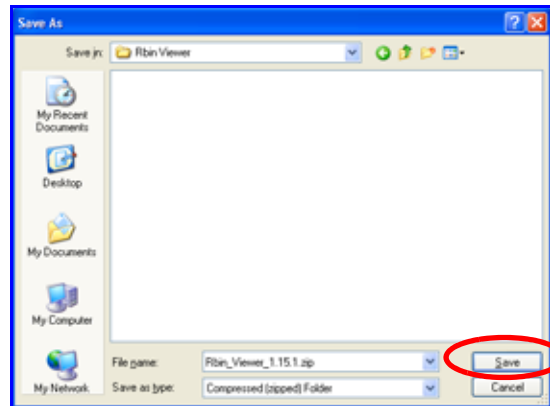

6. Find the folder on your local hard drive where you want to save the Rbin file and click **Save**. The Rbin file in .zip form will be saved to your hard drive under the selected directory.

## Installing the Rbin Viewer

The downloaded Rbin file is in zipped form. You will need to unzip the file before you can install it on your computer. Some operating systems can unzip the file directly. Other systems may require you to download a program to unzip the file.

**Note:** If your computer does not already have the ability to unzip a file, a trial version of WinZip™ software tool is available at:

[www.winzip.com](http://www.winzip.com)

A free version of an unzip program is also available from the following web site:

<http://www.freebyte.com/fbzip/>

To Install the Rbin viewer:

1. Find the directory in which the Rbin .zip file was saved.

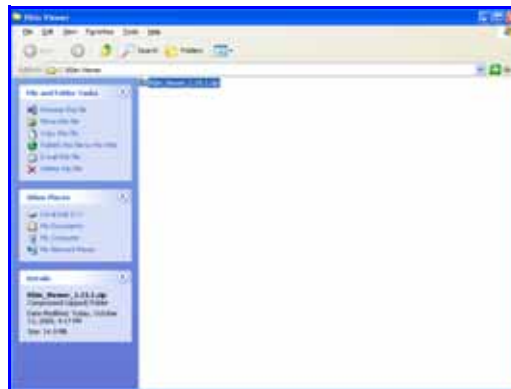

2. Unzip or extract the Rbin Viewer to the desired destination directory. Find the selected directory with the following files.

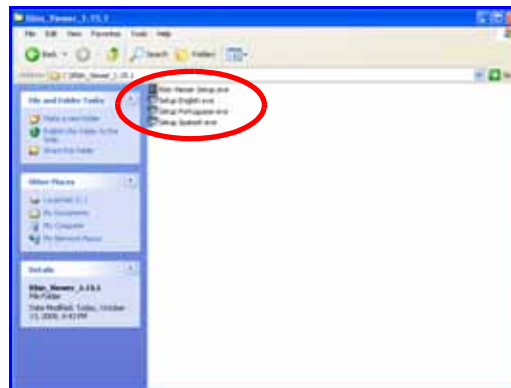

3. Double click the desired language setup file (i.e. Setup English.exe) to begin the installation process.

**Note:** If a Security Warning appears, click the Run button to proceed with the installation of the Raven Rbin Viewer software.

4. The next screen will display the license agreement. Please read or print the agreement before continuing with Rbin Viewer installation.

- Once you have read the license agreement, select the 'I accept the terms in the license agreement' option and then click **Next** to proceed with installation.

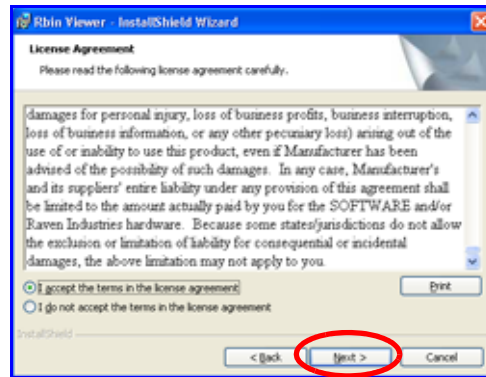

- Please read the Readme Information for release notes and to familiarize yourself with features and any fixes in the latest version of Rbin Viewer.
- Press **Next**.
- The following screen displays. Enter your name and organization. If you choose, you may also restrict the use of the Rbin software to a single user by selecting the "Only for me" option. Click **Next** when finished modifying this screen.

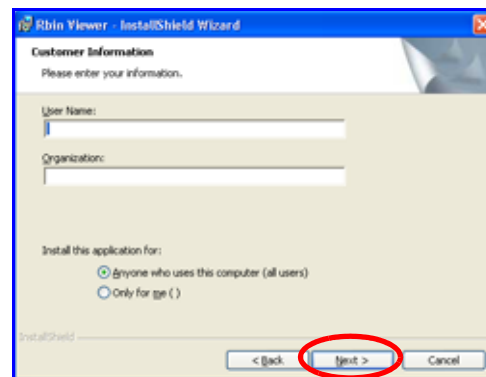

- On the screen that appears, select the option corresponding to the Viper console from which you will be importing information into the Rbin Viewer. If you have both a Viper and Viper Pro console, select the **Viper Pro** option.

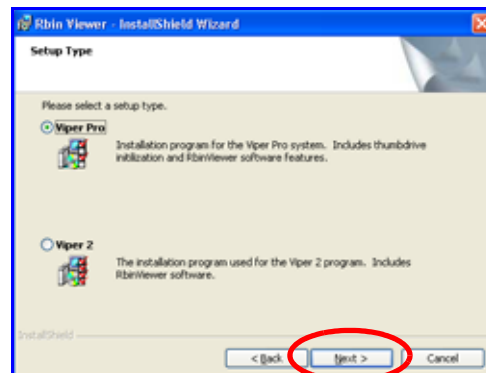

10. Continue clicking **Next** to install all of the software components as prompted. When the following screen appears, click **Install**. The Rbin Viewer software will be installed on your computer. Once installation has been completed, the following screen will display.

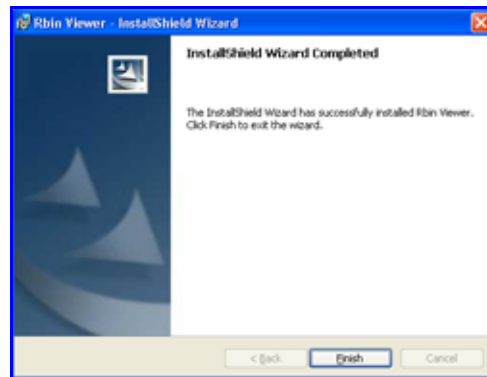

11. Click **Finish** to complete the software installation. The software will open and you can begin using the current version of Rbin Viewer on your computer.

---

## Viewing Rbin Files

You can view application reports that have been created by Viper. These reports include the following:

- Coverage map
- Customer name, address, and identification number
- Operator information
- Field information
- Equipment used to apply the product
- Weather information
- Product information
- Any associated notes

You can use this format to supply reports about the product applied to specific fields.

### To Open an Rbin Report

1. Open the Rbin Viewer on your personal computer.
2. Select **File** from the drop down menu, then click **Open**.

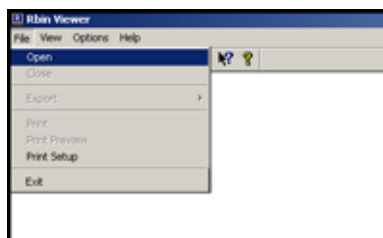



- Browse to find the Rbin report you want to view.

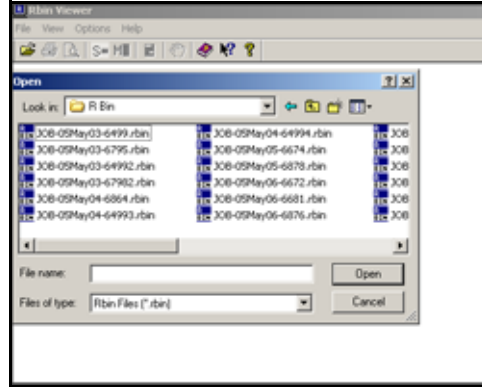

**Note:** You can only view reports stored on your personal computer. You must have previously archived them from your flash drive to your personal computer for them to be available in the Browse list.

- Click **Open**. The report opens in the Rbin Viewer.



- When you are finished viewing the file, you can close the file by selecting **File** from the drop down menu, then **Close**.

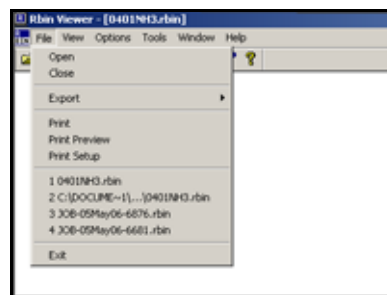



## Exporting Shapefiles

The Rbin report is a simple comprehensive report of the application job. If more detailed information is needed on the application job, Rbin allows you to export more detailed data in the form of a polygon shapefile. The shapefile contains information such as:

- GPS Data
- GPS Time
- GPS Altitude
- GPS COG (course over ground)
- GPS SOG (speed over ground)
- Polygon Data
- Polygon Rate
- Polygon Rate Cal
- Polygon Boom ID
- Polygon Boom Cal
- NDVI data when external serial rate control is used

### To Export a Shapefile

1. Open the Rbin Viewer.
2. Select a file to view.

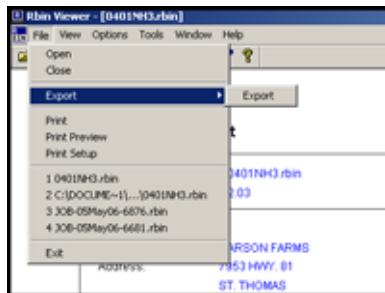

3. Select **File** from the Rbin drop down menu.
4. Select **Export**. The following screen will display.

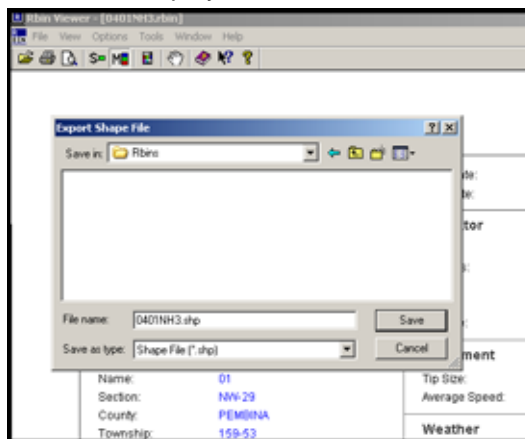

5. Select a folder to save the file in and click to Save. The Rbin will be saved to the folder selected.

## Toolbar Options

The Rbin toolbar contains three icons which provide quick links to coverage map options. These icons allow you to:

- Display coverage map with a single color
- Display coverage map with multiple colors
- Select coverage map colors

To select the coverage display options:

1. Open the desired Rbin file.
2. Select either the **S** (Single Color) or **M** (Multi-color) icon.

**Note:** *In single color mode, any field area that has had product applied to it will be colored in. Only one color will be displayed and no indication will be shown for over or under application.*

*In the multi-color mode, any field area that has had product applied to it will be colored in with one of three colors. These colors define the field application as High, OK, or Low.*

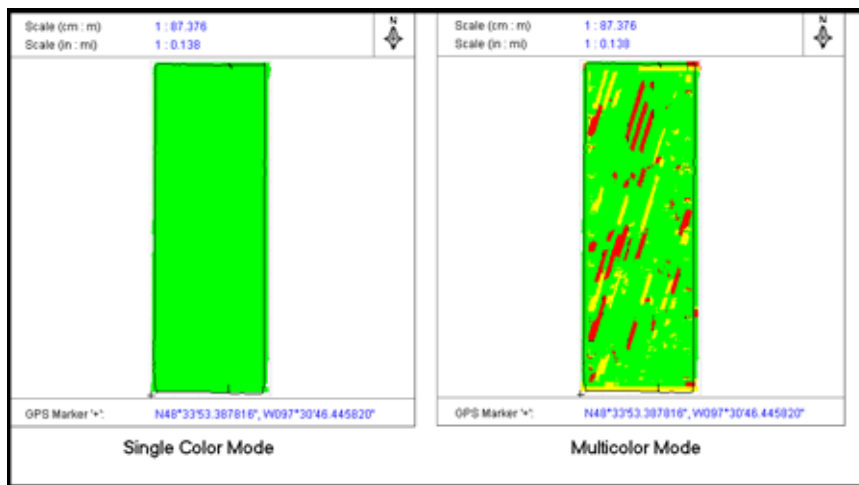

To change coverage map colors:

1. Open the desired Rbin file.
2. Select the **Color Palette** icon from the Rbin toolbar.



3. Select the desired coverage range (**High, OK, or Low**).

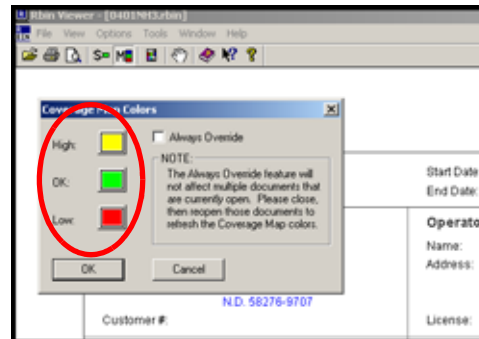

4. Select the desired color and click on **OK** to change the color of the selected application range.

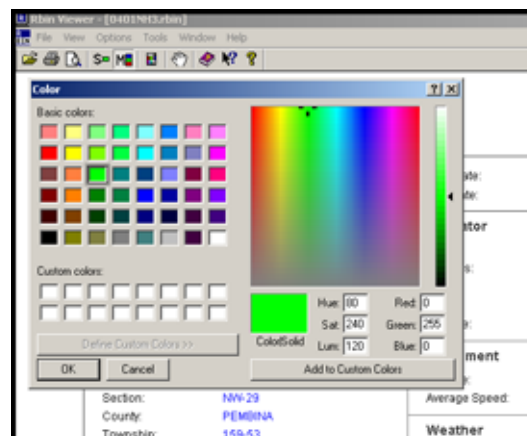

5. Press the **OK** button on the coverage map colors window to finish color selection.

## *Rbin Options*

The Rbin Viewer has several options to allow you to customize the report output. This includes:

- Units
- Layout
- Language
- Manual Console Display
- Export Settings
- Edit Rbin
- Reset History

## To Change the Units of Measure

1. Open Rbin Viewer.
2. Select **Options** from the drop down menu selection.

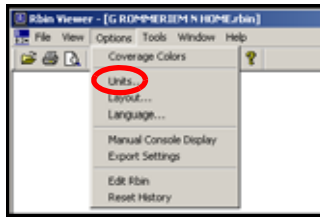

3. Select **Units** from the drop down menu.

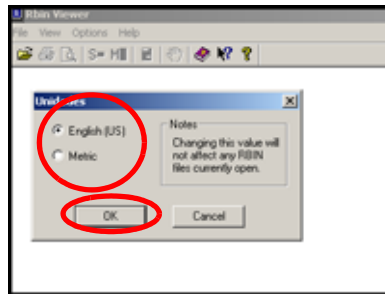

4. Select **English** or **Metric** and press **OK**. The units of measure on the Rbin report will now be in the selected units.

## To Change the Layout

1. Open Rbin Viewer.
2. Select **Options** from the drop down menu selection.

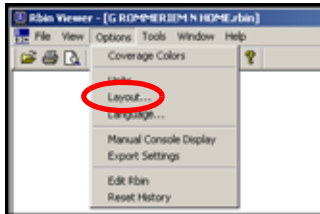

3. Select **Layout** from the drop down menu.

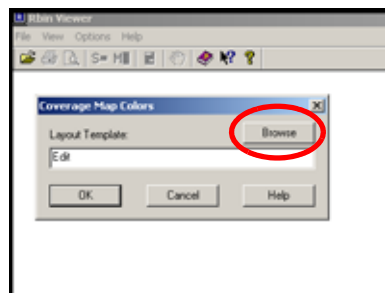

- Click on the **Browse** button.

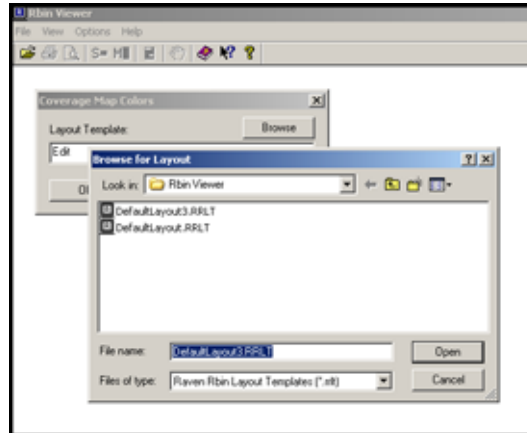

- Select the desired layout, then click the **Open** button.
- Select the **OK** button and the layout will change to the selected layout.

## To Change the Language:

- Open Rbin Viewer.
- Select **Options** from the drop down menu selection.

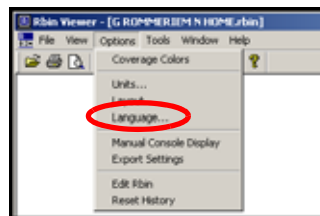

- Select **Language** from the drop down menu.

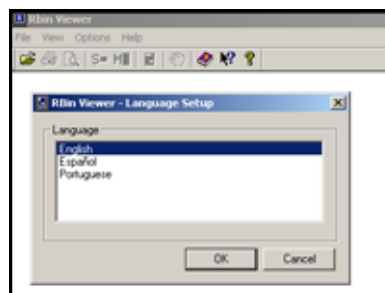

- Select the desired language and press **OK**.

**Note:** You will need to close and reopen the Rbin Viewer before the language changes take affect.

## Enabling Manual Console Display

If an Rbin file has been created with Viper in the Manual Console mode, the standard Rbin report will not display any coverage map as no coverage has been reported to the Rbin report. The Manual Console Display allows you to view the areas of the field that were recorded with the “Boom On”.

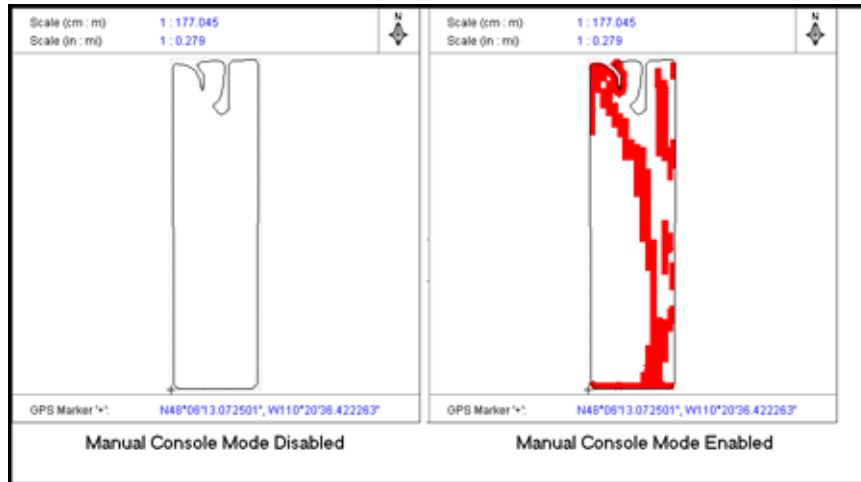

### To Enable Manual Console Display

1. Open the Rbin Viewer.
2. Select a file to be viewed.
3. Select **Options** from the Rbin drop down menu.

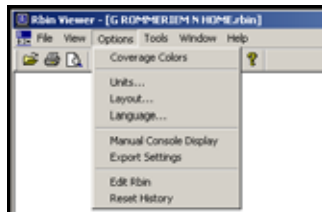

4. Select **Manual Console Display**. The coverage map will now show what parts of the field were recorded with the “Boom On”.

### Export Settings

The Export Settings feature allows you to modify how the Rbin report is displayed. Two setting options are available.

- Show Zero-Rate
- Filter Overlap

**Show Zero Rate** - When the ‘Show Zero Rate’ option is unchecked, the Rbin report will show only those areas that have product applied to them. If the ‘Show Zero Rate’ option is checked, any area that is driven over will be shown whether product was applied or not.

**Filter Overlap** - When making sharp turns with a sprayer, portions of the boom may actually swing backward over pre-applied areas. This will result in small areas of the field being shown as being covered twice in the shapefiles and in the total acreage calculation. When ‘Filter Overlap’ is unchecked, areas may show overlap due to sharp turns and the acreage may be calculated slightly greater than the actual field acreage. With ‘Filter

Overlap' checked, areas covered twice due to sharp turns will be filtered out and the acreage calculated will be closer to the actual acreage of the field.

## To Change The Export Settings:

1. Open the Rbin Viewer.
2. Select a file to be viewed.
3. Select **Options** from the Rbin drop down menu.

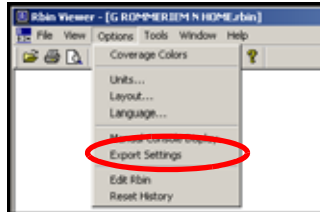

4. Select **Export Settings**. The following screen displays.

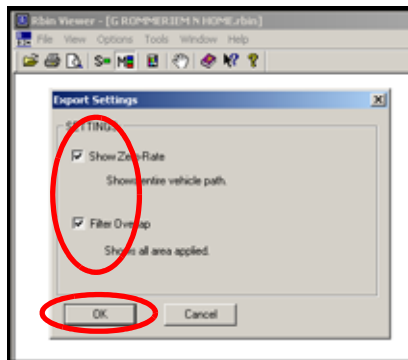

5. Check or un-check the boxes next to 'Show Zero-Rate' and 'Filter Overlap' depending upon the report desired.
6. Press **OK** to return to the Rbin viewer and to apply the settings.

## Editing an Rbin Report

Rbin version 1.12 and above allows you to edit certain fields of data in the Rbin report. The data that can be edited includes:

- Customer Information
- Field Information
- Operator Information
- Miscellaneous Information
- Weather
- Product Information

Rbin also creates a history file on your computer to simplify entering information. Once you have entered key information, Rbin stores this data in a history file. The next time you edit an Rbin, you can select previously entered information from a drop down list, saving you time.

## To Edit an Rbin Report

1. Open Rbin Viewer.
2. Select a file to be edited.
3. Select **Options** from the drop down menu.

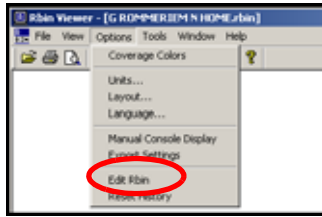

4. Select **Edit Rbin**. The following screen displays.

A screenshot of the 'Edit Rbin...' dialog box. The dialog is divided into several sections: Customer (Name: Peterson Enterprises, Address: 4502 United Road, Ruralton, So. Dak. 57376, Customer #: 475-345), Operator (Name: Williams Sprayers, Address: 451 Rural Road, Agville, So. Dak. 57387, License: BA5669407), Field (Name: Lindsay Farm, Section: 22, County: Roberts, Township: Harmon, Crop: Wheat, Area: [empty], Application Type: Spray, Soil Condition: Dry, Moisture: [empty]), Misc (Tip Size: 4002, Notes: [empty]), and Weather (Observation Time, Temperature, Wind Speed, Humidity, Direction). There are 'Cancel' and 'Next' buttons at the bottom.

5. Edit the data in the fields using the keyboard on your computer.

**Note:** The data you enter into the editing boxes is saved in a history file on your computer. You can pull up this data when you open a new Rbin. The data is automatically sorted in alphabetical order for ease of use.



6. Press **Next**. The following screen displays.

7. Edit the data in the fields using the keyboard on your computer.
8. If you are using a product mix, check the Product Mix box in the desired product information box. When you check the product mix box, the Done button on the Edit Products screen will change to a Next button.



9. Press the **Next** button to go to the Edit Ingredients screen.

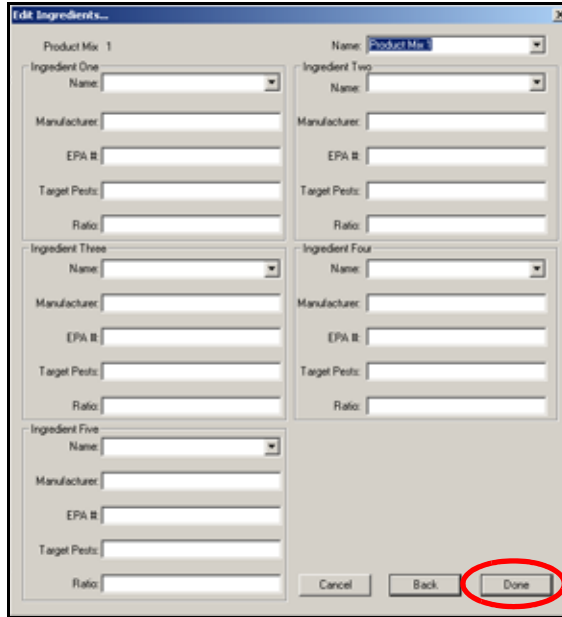

10. Enter the product mix information in the appropriate boxes on the Edit Ingredients screen.
11. When you have completed entering the product mix information, press the **Done** button to save the edits and exit the editing function.

## Reset History

The information typed in while editing an Rbin is stored on your computer in a 'History' file. This file will be added to each time you enter a new Customer, Field, Operator, Miscellaneous item, or Product. Each category is stored in alphabetical order in the history file. You can clean out the history file and start a new history file by using the reset history option.

## To Reset the Edit History

1. Open Rbin viewer.
2. Select a file to be edited.
3. Select **Options** from the drop down menu.

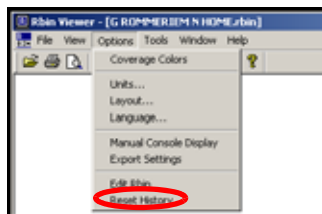

4. Select **Reset History**. The following screen displays.

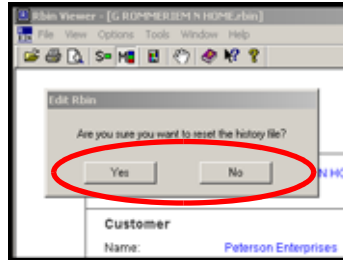

5. Select **Yes** to delete ALL editing history items. Press **No** to save the current editing history items.





CHAPTER

12

*Troubleshooting the Viper Pro System*

This chapter contains information on troubleshooting the Viper Pro system. Please read through all sections in this chapter before contacting technical support, as many common questions are answered here.

*Viper Pro Troubleshooting Information*

This section contains information about possible issues and solutions for the Viper Pro system.

General Issues

Issue	Possible Cause	Solution
Viper does not power up.	<ul style="list-style-type: none"> <li>• No power to unit</li> <li>• Blown fuse</li> <li>• Poor ground</li> </ul>	<ul style="list-style-type: none"> <li>• Check for +12VDC on pin 16 of the Viper power cable.</li> <li>• Check for continuity in 10 amp fuse in Viper power cable.</li> <li>• Make sure that pin 1 is connected to the battery ground.</li> </ul>
CAN nodes not detected.	<ul style="list-style-type: none"> <li>• No power to CAN nodes</li> <li>• Weak or dirty power to the CAN nodes</li> <li>• Water in CAN nodes</li> <li>• Corrosion in CAN connections</li> <li>• Broken cable to node</li> <li>• Low power voltage</li> </ul>	<ul style="list-style-type: none"> <li>• Verify that there is 12 volt power and ground to the CAN node's logic power</li> <li>• Verify that the 12 volt power to the CAN node is coming from the switch relay that is connected to the battery</li> <li>• Do not direct any pressure or wash stream directly at the CAN node(s) to prevent water and moisture from building up in the nodes.</li> <li>• Disconnect and clean the CAN connections.</li> <li>• Repair or replace cable.</li> <li>• Verify at least +10VDC at node.</li> </ul>
Touch screen does not respond to touch	<ul style="list-style-type: none"> <li>• Area touched does not include a selectable function</li> <li>• System is busy processing a previous request</li> </ul>	<ul style="list-style-type: none"> <li>• Touch an area of the screen that contains a selectable function.</li> <li>• Wait for system to finish processing previous requests.</li> </ul>

Issue	Possible Cause	Solution
Red DGPS Status indicator on the Main Screen	<ul style="list-style-type: none"> <li>• GPS cable disconnected</li> <li>• No power to the GPS receiver</li> <li>• Incorrect port setting</li> </ul>	<ul style="list-style-type: none"> <li>• Check the cable between the GPS receiver and the Viper console.</li> <li>• Check power to the GPS receiver.</li> <li>• Make sure that the port settings on the Viper console and the GPS receiver are the same.</li> </ul>
Red 'X' in product control area on the main screen	<ul style="list-style-type: none"> <li>• Control console not turned on</li> <li>• No connection between the Control console and the Viper console</li> <li>• Wrong console selected</li> <li>• Incorrect port setting</li> <li>• Incorrect communications cable</li> <li>• Node connection issue on CAN system</li> </ul>	<ul style="list-style-type: none"> <li>• Turn on the power switch on the control console.</li> <li>• Check the connections between the control console and the Viper console.</li> <li>• Verify the model of the console and select the correct console from the product control setup menu (<b>Menu&gt;Setup&gt;Prod Control&gt;</b>).</li> <li>• Make sure that the communication port settings are the same between the control console and the Viper console.</li> <li>• Use only the supplied communications cable.</li> <li>• See the CAN Troubleshooting section.</li> </ul>
Viper does not completely power down	<ul style="list-style-type: none"> <li>• The orange wire is connected directly to a 12V power source</li> </ul>	<ul style="list-style-type: none"> <li>• Do not connect the orange wire to a source of +12VDC.</li> </ul>
Vehicle battery discharges overnight	<ul style="list-style-type: none"> <li>• CAN nodes are wired directly to the battery</li> </ul>	<ul style="list-style-type: none"> <li>• Wire the CAN nodes through a relay or switched power source.</li> </ul>

## Setup Issues

Issue	Possible Cause	Solution
Previous settings have been lost	<ul style="list-style-type: none"> <li>• Settings data deleted from memory</li> <li>• Poor CAN connections</li> </ul>	<ul style="list-style-type: none"> <li>• Review Chapter 9 and Appendix A for data information.</li> <li>• See the CAN Troubleshooting section.</li> </ul>
Profile displays as default	<ul style="list-style-type: none"> <li>• No profile loaded into Viper</li> </ul>	<ul style="list-style-type: none"> <li>• Create a profile and load it into Viper.</li> </ul>

Issue	Possible Cause	Solution
Streetmaps will not load	<ul style="list-style-type: none"> <li>• The streetmaps files are not located in the streetmaps folder</li> <li>• Streetmaps are located in a sub-folder in the Streetmaps folder</li> <li>• Streetmaps are not in the correct format</li> <li>• Too many streetmaps files in the Streetmaps folder</li> </ul>	<ul style="list-style-type: none"> <li>• Move the streetmaps files to the Streetmaps folder on the disk.</li> <li>• Move the streetmaps to the Streetmaps root folder.</li> <li>• Save the streetmap files in the shapefile format.</li> <li>• Limit the number of county streetmap files in the Streetmap folder.</li> </ul>

### Job Issues

Issue	Possible Cause	Solution
Boom numbers are gray	<ul style="list-style-type: none"> <li>• Boom switches are turned off</li> <li>• AccuBoom enabled but machine not moving</li> <li>• CAN is disconnected</li> </ul>	<ul style="list-style-type: none"> <li>• Turn boom and master switch on.</li> <li>• Move the machine out of the applied zone.</li> <li>• See the CAN Troubleshooting section.</li> </ul>
Boom number does not turn green when turned on	<ul style="list-style-type: none"> <li>• The boom is not set up properly</li> <li>• Nodes not completely programmed</li> <li>• The boom is disconnected</li> </ul>	<ul style="list-style-type: none"> <li>• Check the boom setup from the Setup menu.</li> <li>• Check Node calibration and ensure all calibration is completed.</li> <li>• Check the connection and wiring to the boom.</li> </ul>
Serial Console AccuBoom controlled boom sections will not turn off	<ul style="list-style-type: none"> <li>• Boom switches on console are in the 'On' position</li> </ul>	<ul style="list-style-type: none"> <li>• Boom switches for Parallel AccuBoom must be in the 'Off' position.</li> </ul>
CAN System AccuBoom will not turn on	<ul style="list-style-type: none"> <li>• Boom switches are in the 'Off' position</li> </ul>	<ul style="list-style-type: none"> <li>• Boom switches for CAN AccuBoom must be in the 'On' position.</li> </ul>
Product function keys do not work	<ul style="list-style-type: none"> <li>• Not a CAN system</li> <li>• Product application is turned off</li> </ul>	<ul style="list-style-type: none"> <li>• Product function keys work only in a CAN system.</li> <li>• Switch product application to either auto or manual mode.</li> </ul>
Dates and time are incorrect	<ul style="list-style-type: none"> <li>• No GPS</li> <li>• No GPS RMC or ZDA</li> <li>• Incorrect time zone selected</li> </ul>	<ul style="list-style-type: none"> <li>• Make sure that the GPS receiver is operating properly and that there is a green 'thumbs-up' icon displayed in the GPS section of the main screen.</li> <li>• Check the GPS receiver to make sure the RMC or ZDA string is selected.</li> <li>• Verify the time zone selected in the <b>Menu/Setup/Local/Time Zone</b> section.</li> </ul>



<b>Issue</b>	<b>Possible Cause</b>	<b>Solution</b>
Product spread in zero rate zones	<ul style="list-style-type: none"> <li>• Bed creep</li> <li>• Wrong valve type on vehicle</li> <li>• Incorrect valve setting</li> </ul>	<ul style="list-style-type: none"> <li>• Adjust hydraulic valve to stop the bed creep.</li> <li>• Must use either a Fast Close or PWM Close valve.</li> <li>• Check valve or PWM setting.</li> </ul>

## Rx Map Issues

<b>Issue</b>	<b>Possible Cause</b>	<b>Solution</b>
Only one prescription map loads	<ul style="list-style-type: none"> <li>• You have a single product registration</li> </ul>	<ul style="list-style-type: none"> <li>• Purchase a multi-product registration from your distributor.</li> </ul>
The prescription map does not display properly	<ul style="list-style-type: none"> <li>• Wrong datum type</li> </ul>	<ul style="list-style-type: none"> <li>• Use WGS-84 decimal degrees when creating an Rx map.</li> </ul>

## Coverage Map Issues

<b>Issue</b>	<b>Possible Cause</b>	<b>Solution</b>
Gaps displayed in coverage map	<ul style="list-style-type: none"> <li>• Boom widths not set correctly</li> <li>• Guidance and boom width not the same</li> </ul>	<ul style="list-style-type: none"> <li>• Check boom widths and boom center values.</li> <li>• Set guidance width and boom width to the same value.</li> </ul>
Product coverage displayed in zero rate zones	<ul style="list-style-type: none"> <li>• Vibration chatter in encoder</li> <li>• Valve or motor is not set to close completely</li> </ul>	<ul style="list-style-type: none"> <li>• Make sure that the encoder is firmly mounted. Increase value in "Zero Rate Tolerance."</li> <li>• Adjust valve or motor to close or stop completely with no rate applied.</li> </ul>
Cannot achieve target rate	<ul style="list-style-type: none"> <li>• Driving too fast for vehicle</li> <li>• Calibration numbers incorrect</li> <li>• Speed calibration incorrect</li> </ul>	<ul style="list-style-type: none"> <li>• Speed may exceed capabilities of vehicle to deliver product. Slow down the vehicle or configure the vehicle to supply a higher amount of product.</li> <li>• Check and adjust meter calibration, density, and other calibration numbers.</li> <li>• Check and adjust speed calibration setting.</li> </ul>



## Error Messages

The following table provides issues and solutions about error messages displayed on the Viper system.

### General Error Messages

Issue	Possible Cause	Solution
The Activation key you have entered is not valid	<ul style="list-style-type: none"> <li>• Incorrect Activation key entered</li> </ul>	<ul style="list-style-type: none"> <li>• Re-enter the Activation key. If this still does not work, contact your Raven representative.</li> </ul>
Scout file error	<ul style="list-style-type: none"> <li>• Scout file for one of the jobs is missing</li> <li>• File is an older version and not compatible with the current software release</li> </ul>	<ul style="list-style-type: none"> <li>• Press <b>OK</b> to bypass.</li> <li>• Press <b>OK</b> to bypass.</li> </ul>
JobMap error	<ul style="list-style-type: none"> <li>• Scout file for job is missing</li> </ul>	<ul style="list-style-type: none"> <li>• Press <b>OK</b> to bypass and create a scout file for the current job.</li> </ul>

### Setup Error Messages

Issue	Possible Cause	Solution
Booms must be specified in left-to-right order	<ul style="list-style-type: none"> <li>• Booms are not configured sequentially in a left-to-right order</li> </ul>	<ul style="list-style-type: none"> <li>• Configure the boom in a left-to-right order. See Chapter 3, Boom Settings and Mapping for more information on configuring booms.</li> </ul>
There is a gap or overlap between boom sections	<ul style="list-style-type: none"> <li>• Improper values entered into either boom widths and/or the left/right values for individual boom sections.</li> </ul>	<ul style="list-style-type: none"> <li>• Check the boom setup values entered for Left/Right, and check the booms you have entered for this product. Set up boom sequentially from left-to-right. Left/Right value is measured from center of boom.</li> </ul>
	<ul style="list-style-type: none"> <li>• Boom select functions not properly configured.</li> </ul>	<ul style="list-style-type: none"> <li>• Boom select must specify individual booms for individual products if a gap or overlap is detected.</li> </ul>
Missing Scout File	<ul style="list-style-type: none"> <li>• Scout files have been deleted from the scout folder but other folders contain files associated with the job.</li> </ul>	<ul style="list-style-type: none"> <li>• If you are not working on the specified job, delete all files with the same name from all the other folders on the flash disk. Use the File Maintenance function to delete the remaining files. Make sure to keep a backup on your personal computer if you want to use the job again.</li> </ul>
Rx Colors error. "You must enter a name for this template"	<ul style="list-style-type: none"> <li>• The custom RxMap Colors was selected but no name was given to the template</li> </ul>	<ul style="list-style-type: none"> <li>• Enter a name for the custom Rx Color template.</li> </ul>
RxColor error. "You must pick a color for entry Minimum"	<ul style="list-style-type: none"> <li>• There is no color selected for the range</li> </ul>	<ul style="list-style-type: none"> <li>• Press <b>Select</b> and select a color for the minimum level.</li> </ul>
Could not grow buffer	<ul style="list-style-type: none"> <li>• Streetmaps that are being installed are too large for the Viper system memory</li> </ul>	<ul style="list-style-type: none"> <li>• Limit streetmaps to four counties or less, depending upon the file size. More densely populated counties have a larger file size than sparsely populated counties.</li> </ul>



## Job Error Messages

Issue	Possible Cause	Solution
Open New Job error	<ul style="list-style-type: none"> <li>For non-VRC (Variable Rate Control) jobs, you must have GPS coverage before starting the job</li> </ul>	<ul style="list-style-type: none"> <li>Check for GPS signal.</li> </ul>
No GPS Coverage Warning: You must have GPS coverage if you start a non-VRC job.	<ul style="list-style-type: none"> <li>Displays when starting a job without a GPS signal</li> </ul>	<ul style="list-style-type: none"> <li>Check for GPS Signal.</li> </ul>
Missing Product Information: No Product Name Entered	<ul style="list-style-type: none"> <li>No product name entered</li> </ul>	<ul style="list-style-type: none"> <li>Enter a least one character for a product name.</li> </ul>
Job is opened in View mode only.	<ul style="list-style-type: none"> <li>Existing job was started in View mode only. No changes can be saved.</li> </ul>	<ul style="list-style-type: none"> <li>Close the job and restart in 'Add to Job' mode.</li> </ul>
You must set up the boom information in the Setup menu	<ul style="list-style-type: none"> <li>When starting a job, this message displays if the booms have not been setup</li> </ul>	<ul style="list-style-type: none"> <li>Configure the boom information in the Setup menu.</li> </ul>
You have not set up all of the products for this job	<ul style="list-style-type: none"> <li>You have not entered the information for all of the products during the job setup routine.</li> </ul>	<ul style="list-style-type: none"> <li>Make sure that all products have an assigned product name.</li> </ul>
You must select at least 1 boom for this product	<ul style="list-style-type: none"> <li>Every product in the system must have at least one boom section assigned to it.</li> </ul>	<ul style="list-style-type: none"> <li>Using the Boom Select option, check at least one boom section for the product.</li> </ul>
The Boom Settings for this job do not match your current boom setup. Cannot add to this job.	<ul style="list-style-type: none"> <li>When adding to an existing job, all boom settings must match exactly the boom configuration when the job was originally started.</li> </ul>	<ul style="list-style-type: none"> <li>Re-configure your boom setup to match the configuration when the job was originally started.</li> </ul>

## Variable Rate Control (VRC) Error Messages

Issue	Possible Cause	Solution
Browse Rx Files	<ul style="list-style-type: none"> <li>VRC must be selected in order to enter prescription information</li> </ul>	<ul style="list-style-type: none"> <li>Select VRC in the Product Setup screen.</li> </ul>
VRC must be selected in order to enter prescription information	<ul style="list-style-type: none"> <li>VRC was not selected during the product setup</li> </ul>	<ul style="list-style-type: none"> <li>Select VRC in the Product Setup screen.</li> </ul>
No VRC Products	<ul style="list-style-type: none"> <li>There are no more selections to make</li> </ul>	<ul style="list-style-type: none"> <li>Press <b>OK</b> to start the job.</li> </ul>

Issue	Possible Cause	Solution
No Rx file chosen for this product	<ul style="list-style-type: none"> <li>• VRC was selected for the product during the product setup, but no Rx map was loaded</li> </ul>	<ul style="list-style-type: none"> <li>• Un-select the VRC selection or load an Rx map for the product.</li> </ul>
No Rx rate field chosen for product	<ul style="list-style-type: none"> <li>• VRC was selected and an Rx map was loaded, but a selection was not made in the Rate field</li> </ul>	<ul style="list-style-type: none"> <li>• Select the appropriate item from the Rate field.</li> </ul>
When VRC is checked, a Prescription File and Rate Field must be supplied	<ul style="list-style-type: none"> <li>• VRC was selected during the product setup, but a prescription map and rate field have not been selected</li> </ul>	<ul style="list-style-type: none"> <li>• Press <b>Browse</b> to select the appropriate prescription file. Select the appropriate rate item in the Rate field.</li> </ul>
Color templates are available only when VRC is selected	<ul style="list-style-type: none"> <li>• You selected a color template without selecting VRC</li> </ul>	<ul style="list-style-type: none"> <li>• You can only select a color template when you have selected VRC and have loaded a prescription map.</li> </ul>

## GPS Error Messages

Issue	Possible Cause	Solution
No GPS Coverage warning	<ul style="list-style-type: none"> <li>• You must have GPS coverage to start a non-VRC (Variable Rate Control) job</li> </ul>	<ul style="list-style-type: none"> <li>• Make sure that the GPS data is being received by the Viper system.</li> </ul>
Warning: You do not have optimum GPS coverage. Some features may be disabled.	<ul style="list-style-type: none"> <li>• GPS reception does not have differential correction. Therefore, some features, such as guidance, will not be available when starting a job in this condition</li> </ul>	<ul style="list-style-type: none"> <li>• Enable the differential correction function in the GPS receiver. Contact the receiver manufacturer for additional information.</li> </ul>
No Differential	<ul style="list-style-type: none"> <li>• Differential GPS has not been detected by Viper</li> </ul>	<ul style="list-style-type: none"> <li>• Check the GPS receiver to make sure that it has the differential correction function. Contact the manufacturer for additional information.</li> </ul>
No GPS	<ul style="list-style-type: none"> <li>• Viper does not detect a GPS signal</li> </ul>	<ul style="list-style-type: none"> <li>• Make sure that the GPS receiver is turned on and receiving a signal.</li> <li>• Make sure that the port setting for Viper and the GPS receiver match.</li> <li>• Make sure that the required NMEA messages are turned on in the GPS receiver.</li> </ul>



## CAN Troubleshooting

Although the control algorithm is located within the CAN node, all of the same troubleshooting techniques that you use in a traditional hard-wired system still apply to a CAN system. CAN allows for modularization of the control system, but the behavior of the system remains the same. Flow and speed sensors, as well as the control valve and boom valves, are used in the same fashion.

Below are some common causes for communication failures:

Issue	Possible Cause	Solution
CANbus cannot read the product node	<ul style="list-style-type: none"> <li>• The node is not connected to the CANbus</li> </ul>	<ul style="list-style-type: none"> <li>• Connect the node and re-initialize the Viper console to read the product node.</li> </ul>
Node is not properly powered	<ul style="list-style-type: none"> <li>• Check and reconnect the power</li> </ul>	<ul style="list-style-type: none"> <li>• Connect the Clean Power - 16 gauge red wire and High Current Power - 12 gauge red wire from the product node to a 12VDC power source that is capable of supplying power to all nodes connected to the CANbus system</li> </ul>
Node is not properly grounded	<ul style="list-style-type: none"> <li>• Check and ground the node</li> </ul>	<ul style="list-style-type: none"> <li>• Connect the Clean Ground - 16 gauge white wire and the High Current Ground - 12 gauge white wire to a good, quality ground source. Raven recommends grounding the wires to the negative terminal of the battery.</li> </ul>
The Boom/Speed node share power and ground connections	<ul style="list-style-type: none"> <li>• Distribute power and ground</li> </ul>	<ul style="list-style-type: none"> <li>• Make sure that each node has a separate power and ground connection.</li> </ul>
CANbus ends not terminated	<ul style="list-style-type: none"> <li>• Terminate CANbus ends</li> </ul>	<ul style="list-style-type: none"> <li>• Make sure that both ends of the CANbus system are properly terminated. See Chapter 2 for more information.</li> </ul>

---

APPENDIX

*System Diagrams*

**A**

The following diagrams may be helpful for installing or troubleshooting the Viper Pro console or Product Control system. The following diagrams may show optional features or components not required for operation and will not apply to your system if the required hardware has not been installed.

Contact your local dealer for purchasing or more information on components shown in the following diagrams.

Additional system diagrams are available (free of charge) from the Raven Industries web site:

<http://www.ravenprecision.com/Support/ApplicationDrawings/index2.jsp>

---

*Viper Pro Serial Console Connection  
(Optional)*

1. Connect one end of the Raven RS-232 cable to the connector labeled "Console" on the end of the Viper interface cable.
2. Connect the other end to the serial port connector on the back of the Raven SCS console.

FIGURE 1. Serial Control Console to Viper Pro Connection Example

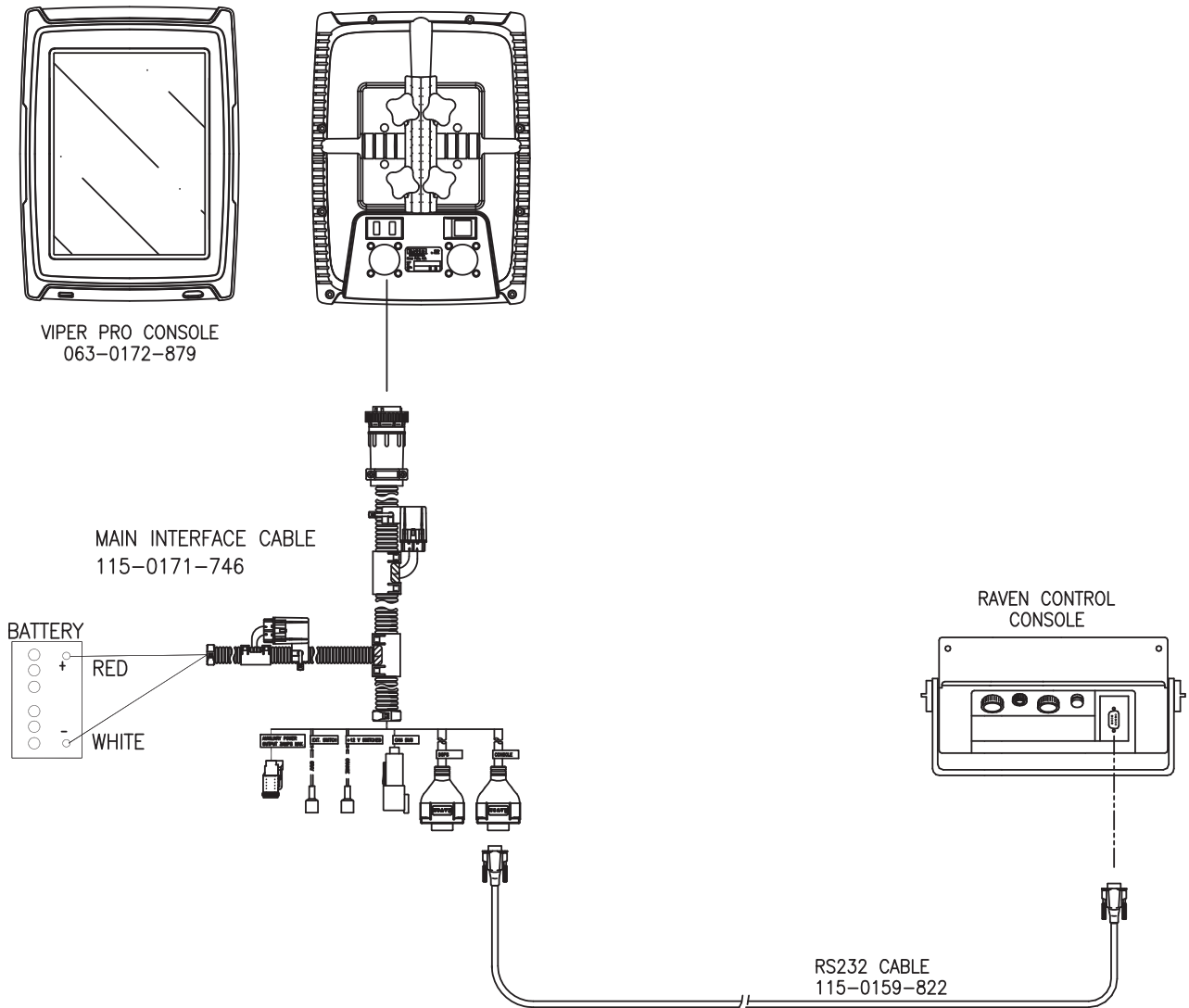

**Note:** Use only a Raven RS-232 communication cable between the Viper system and the SCS console. This cable is available as listed below. Contact your Raven distributor for purchasing and more information.

Part	Part Number
RS-232 cable - 3 ft.	115-0171-040
RS-232 cable - 10 ft.	115-0159-822

## Viper Pro with External Lightbar

Connect the lightbar to the COM3 port on the Viper Pro Auxiliary Interface cable. Refer to the following figure and follow the lightbar installation instructions.

FIGURE 2. External Lightbar Connection

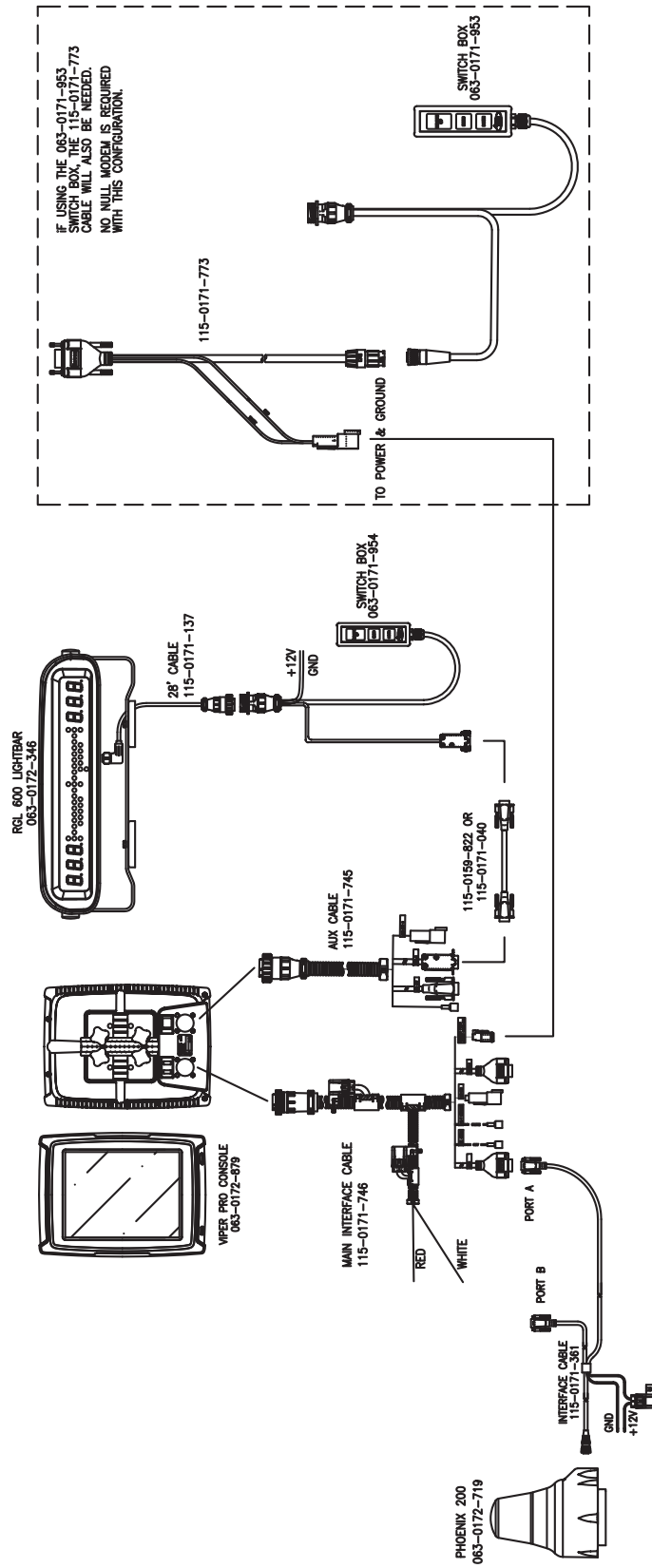
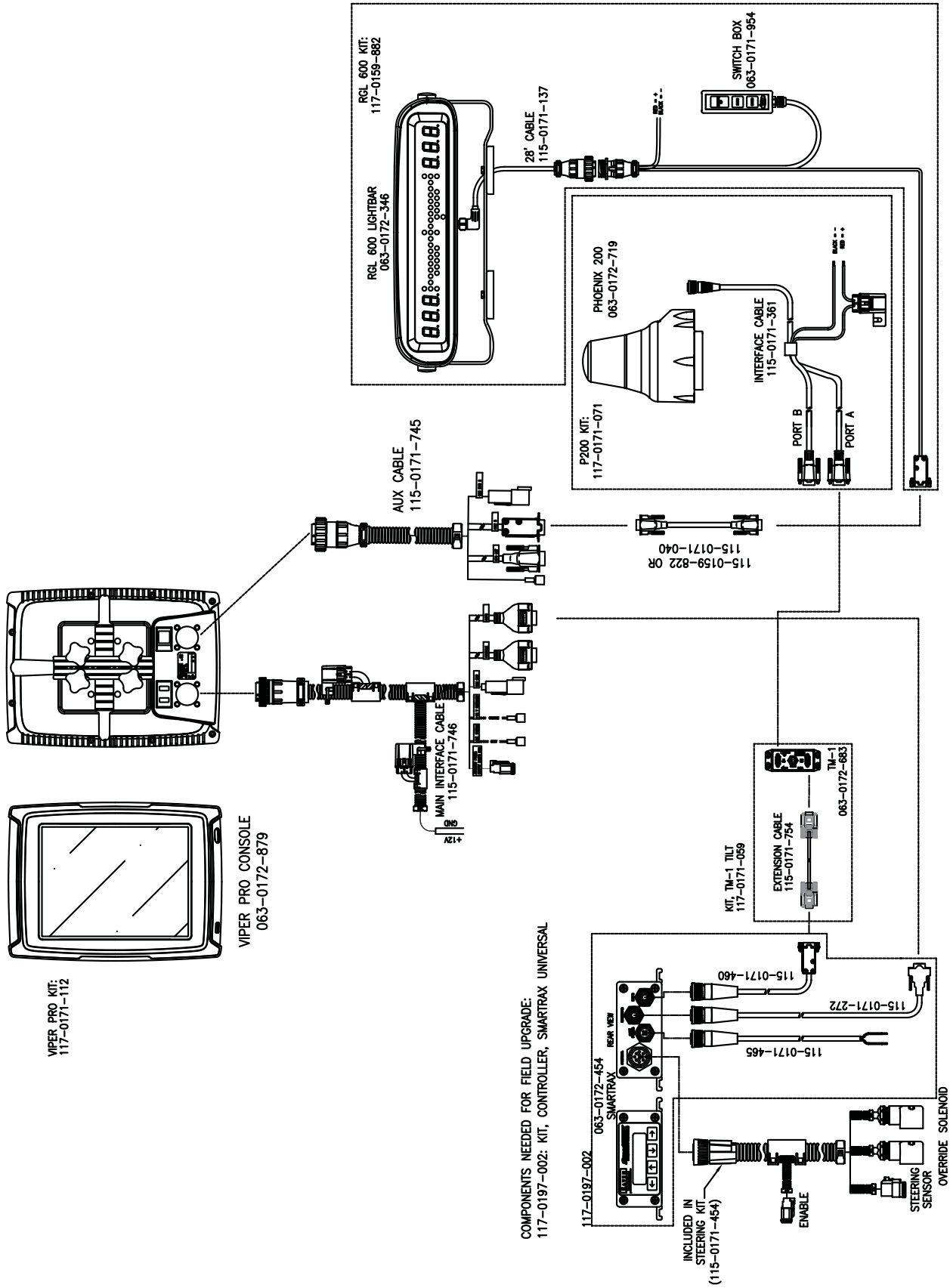

FIGURE 3. Viper Pro/Phoenix 200/RGL 600 Universal/SmarTrax™ Package









---

## *Viper Pro File Structure*

As explained in Chapter 1, *Introduction*, the Viper Pro uses information stored in internal memory to operate while running. Proper file maintenance is the key to successful Viper Pro operation.

When you first start using your Viper Pro console, the internal Viper operating system automatically creates certain files and folders on the internal memory. These files and folders will be where the Viper Pro system later stores data files, such as navigation files, map files, and job files. Below is a list of the files and folders that Viper automatically creates on the internal memory:

- AccuBoom folder
- AutoBoom Alarms folder
- boundaryShp folder
- clone folder
- covMaps folder
- guideArchive folder
- jobs folder
- rbin folder
- rxMaps folder. This folder also contains the sub-folder colors.
- scout folder
- settings folder
- streetmaps folder
- vnav folder
- zulu.ini file

### AccuBoom™ Folder

The AccuBoom folder contains the AccuBoom spray/no-spray boundary maps with a .sct extension. Viper creates one file for each AccuBoom job.

You should store any previously created AccuBoom spray/no-spray field boundary maps in this folder to make sure that any .shp, .shx, and .dbf files associated with the field boundary files are also stored here.

These files are used by the Viper Pro OS and are not viewable.

### AutoBoom Alarms

The AutoBoom Alarms folder will be created if Enable Alarm Logging is checked in the AutoBoom control screen. The AutoBoom Alarm folder will create a new file each time the Viper is started. The AutoBoom Alarm files have a .txt extension and can be read by any text editor.

You do not need to save these files and this folder can be cleaned off the card during card maintenance.

### BoundaryShp Folder

The boundaryShp folder contains any shapefiles for field boundaries created using GIS software and transferred to the Viper Pro console.

**Note:** *Field Boundaries created using the Viper Pro are saved as a part of the Job file.*

*Shapefiles within this folder must have the .shp, .shx, and .dbf extension.*

### Clone Folder

The clone sub-folder will only appear on the USB drive if a clone of the Viper Pro has been created. Clones may be used as “restore points” to quickly and easily reset the Viper Pro console to a previous set up. A clone will contain the following files contained within the Viper Pro file structure:

- Coverage Maps
- Prescription Maps
- Streetmaps
- Scout Maps
- A-B Lines
- Job files
- Rbin files
- Boom Configuration
- AccuBoom Configuration
- Comm Port settings

Refer to *Clone or Restore Settings* section on page 168 for instructions on using clone files.

### CovMaps Folder

The covMaps folder contains product coverage map files that have a .cov extension. Viper saves one coverage file for each product and each job.

It will also contain boom control data files if you have purchased the AccuBoom Control feature for the Viper Pro system. These files have a .bct extension. Viper Pro saves one file for each job.

These files are used by the Viper Pro OS and are not viewable.

### GuidanceArchive Folder

The GuideArchive folder contains the guidance A-B lines saved in files with a .ab extension. You should store any previously created A-B lines in this folder.

These files are used by the Viper Pro OS and are not viewable.

---

## Jobs Folder

The jobs folder contains general job information files that have a .job extension. Viper Pro saves one file for each job.

These files are used by the Viper Pro OS and are not viewable.

## Rbin Folder

The rbin folder contains the Viper Pro log files. These files contain the information needed to create the Application report. You will need the Rbin Viewing Utility software to view and print the Application report. This utility also allows you to export the rbin file to a shapefile format to use in other software programs. Raven supplies the Rbin Viewer utility free of charge to registered Viper users. It is also recommended that you archive rbins for future reference.

## RxMaps Folder

The RxMaps folder contains the prescription maps used for future jobs. You must save the .shp, .shx, and .dbf files associated with the prescription map to this folder. Viper Pro uses these files to generate a file with a .mem extension that is used by the Viper Pro OS.

The .mem file is not viewable.

## RxMaps\colors Sub-folder

The colors sub-folder contains the color information files for the prescription maps and has a .rxc extension. Viper Pro creates these maps when you create a color template for a prescription map. Viper Pro saves one file for each template.

These files are used by the Viper Pro OS and are not viewable.

## Scout Folder

The scout folder contains the scouting information files with a .sct extension if you are using scouting information for your fields. Viper Pro creates one file for each job.

You should store previously created field boundaries in this folder and make sure that any .shp, .shx, and .dbf files associated with the field boundary files are also stored here.

These files are used by the Viper Pro OS and are not viewable.

## Settings Folder

The settings folder contains the information files used exclusively by the Application report. There are two files in the folder, a file with a .cbo extension and a file with a .cbx extension.

The .cbo file contains information associated with drop-down combo lists, such as customer, fields, and driver information. The .cbx file contains information associated with the information in the .cbo file. For example, when you enter such customer information as name, address, and city, the .cbo file stores the customer name

information and the .cbx file stores the address and city information associated with the customer name. This folder also contains machine profiles.

These files are used by the Viper Pro OS and are not viewable.

### Streetmaps Folder

The streetmaps folder contains the downloaded Tiger road files. You must make sure that you have all three files (.shp, .shx, and .dbf) associated with the road maps for each county.

These files are used by the Viper Pro OS and are not viewable.

### Vnav Folder

The vnav folder contains the swath settings and guidance status information that have a .vnav extension. Viper Pro saves this information only if you have the guidance feature and you have used the feature for a job.

These files are used by the Viper Pro OS and are not viewable.

### Zulu.ini File

The zulu.ini file contains the configuration and user settings for the Viper Pro console. This file is specific to the Viper Pro with which it is being used.

These files are used by the Viper Pro OS and are not viewable.

---

## *Maintaining the Storage Memory*

You should maintain the Viper Pro storage memory by moving the files or folders to your desktop or laptop computer on a regular basis. This prevents the memory from becoming full. Raven recommends moving only the Rbin files to your computer. If you want to view existing jobs or add jobs at a later date, you must save all files associated with those jobs to your computer.

Once you have saved the Rbin files to your computer, you can delete the covMaps, jobs, and vnav files from the internal memory.

Do not allow the storage memory to become more than 80% full. If the storage memory becomes more than two-thirds full, a Storage Memory warning displays. Save files to your computer or delete unwanted files to add more storage space to the storage memory.

Refer to Chapter 10, *File Maintenance*, for more information on maintaining your flash disk.

APPENDIX

C

*Calculating the Boom  
Width (Calibration) for  
Liquid Applications*

You can calculate boom calibration for two different types of spray applications, Broadcast spraying and Band spraying.

---

*Broadcast Spraying*

You can calculate the boom section width with the formula:

$$T \times S = BSW$$

Where T = the number of Tips in each boom section, S = the spacing between tips, and BSW = the Boom Section Width.

***For Example:***

20 tips in a boom section with spacing of 40 inches would yield:

$$BSW = 20 \times 40 = 800$$

or a Boom Section Width of 800 inches (approximately 67 feet). You should enter 800 as the boom width for this section.

## *Band Spraying*

To calculate the adjusted applied rate for band spraying applications, use the following formula:

$$\frac{BR \times BW}{S} = AR$$

Where BR = the Broadcast Rate, BW = the bandwidth, S = the spacing between the tips, and AR = the Adjusted Rate for band spraying.

### ***For Example:***

If your Broadcast Rate is 20 GPA, the band width is 14 inches, and the tip spacing is 40 inches:

$$AR = \frac{20 \times 14}{40} = 7$$

Therefore, the adjusted rate is 7 GPA.



## APPENDIX

# D

## *Calculating and Verification of Spreader Constant*

---

### *Calculation of Spreader Constant*

#### Standard RATE display

For RATE displayed in 1 lb. increments, the formula to calculate the Spreader Constant is:

$$SC = \frac{311,040}{L \times GH \times GW}$$

Where SC = the Spreader Constant, L = Length of belt travel in inches per 1 revolution of the encoder, GH = Gate Height in inches, GW = Gate Width in inches.

#### ***For Example:***

Given a Length of belt travel of 13 inches, a Gate Height of 7 inches, and a Gate Width of 15 inches:

$$\frac{311,040}{13 \times 7 \times 15} = 228$$

or a Spreader Constant of 228.

#### Metric RATE Display

For RATE displayed in 1 kg. increments, the formula to calculate the Spreader Constant is:

$$SC = \frac{18,000,000}{L \times GH \times GW}$$

Where SC = the Spreader Constant, L = Length in centimeters of belt travel per 1 revolution of the encoder, GH = Gate Height in centimeters, and GW = Gate Width in centimeters.

**For Example:**

Given a Length of belt travel of 33 cm, a Gate Height of 18 cm, and a Gate Width of 38 cm:

$$\frac{18,000,000}{33 \times 18 \times 38} = 797$$

Enter 797 as the Spreader Constant if you want to display metric units.

---

*Verification of Spreader Constant*

To verify and refine the spreader constant, perform the following procedure after completing the initial setup of the Viper system.

1. Weigh loaded truck and record weight.
2. Enter the product density in lbs/cu. ft. [grams/liter] into the Density field in the Data Box 2 section.
3. Set the total volume to zero for the product node being tested.
4. With the product node in the MAN position, unload a portion of the load by positioning the boom switch to 'ON'.
5. Determine the actual weight unloaded by re-weighting the truck.
6. Compare this weight to the total volume displayed on the Viper display.
7. Perform the following calculation to correct the spreader constant, if desired:

Corrected Spreader Constant =

$$\frac{OSC \times TV}{AW} = CSC$$

Where OSC = the Old Spreader Constant, TV = the Total Volume, and AW = the Actual Weight unloaded.

**For Example:**

Given:

- Old Spreader Constant = 228 [797]
- Total Volume amount = 2000 lbs [4400 kg]
- Actual Weight Unloaded = 1950 lbs [4290 kg]

A Corrected Spreader Constant in English units:

$$\frac{228 \times 2000}{1950} = 234$$

The new Spreader Constant is 234.

A Corrected Spreader Constant in Metric units:

$$\frac{797 \times 4400}{4290} = 817$$

Repeat this procedure until the weight of the metered materials equals the total volume value.

## APPENDIX

# E

## Calculating Speed Calibration

To ensure that you are applying the correct amount of product to a field, you must calibrate the speed of the vehicle to the Viper system. Confirm that the Speed Cal is set to 598 (English units) or 152 (Metric units). The following instructions show you how to properly calculate the correct speed calibration.

### Calculating the Speed Calibration

1. Press **Product Control**, then **Tally Registers**. The Tally Registers screen displays.

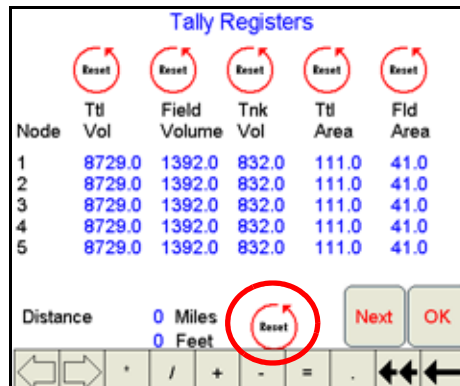

Node	Ttl Vol	Field Volume	Trnk Vol	Ttl Area	Fid Area
1	8729.0	1392.0	832.0	111.0	41.0
2	8729.0	1392.0	832.0	111.0	41.0
3	8729.0	1392.0	832.0	111.0	41.0
4	8729.0	1392.0	832.0	111.0	41.0
5	8729.0	1392.0	832.0	111.0	41.0

Distance 0 Miles 0 Feet

Reset Next OK

2. Press **Reset** next to the Distance reading.
3. Drive the vehicle a distance of one mile (or one kilometer if using metric units).

**Note:** Do not use the odometer on the vehicle to determine the distance. Use either section lines or highway markers to ensure that you have driven the correct distance.

4. Read the distance value displayed in the Feet field. This value should be 5280 if you drove the vehicle exactly one mile.

If the value displayed in the Feet field is between 5260 and 5300, the Speed Cal number entered is correct. If the distance displays a value that is outside the above range, perform the following calculation to determine the speed calibration:

$$\frac{OSC \times 5280}{D} = CSC$$

Where OSC = the Old Speed Cal value, D = the Viper Pro odometer reading, and CSC = the Corrected Speed Cal.

***For Example:***

in English Units:

Using the default Speed Cal of 598, and a Viper Pro odometer reading of 5000:

$$\frac{598 \times 5280}{5000} = 631$$

the Corrected Speed Cal is 631.

in Metric units:

$$\frac{152 \times 1000}{980} = 155$$

Therefore, the Corrected Speed Cal equals 155.

5. Enter 631 (for English units) or 155 (for Metric units) for the Speed Cal.
6. Confirm that the new Speed Cal is correct by repeating steps 2 through 4 above.

## APPENDIX

# F

## *Calculating Calibrations for Liquid and Granular Applications*

### *Calculating Valve Calibration*

To ensure that you are applying the proper amount of product to the field, you must calibrate the valves used to deliver the product. Viper uses the valve calibration number to control the response time of the control valve motor to changes in the vehicle speed.

The following control valve calibration numbers are recommended for the valves listed:

Valve Name	Calibration Number
Standard Valve	2123
Fast Close Valve	743
Fast Valve	743
PWM Valve	43
PWM Close Valve	43
Standard Motor Control Valve	123

Each digit in the calibration number corresponds to a specific function of the valve. The following functions apply to the digits in the valve calibration number:

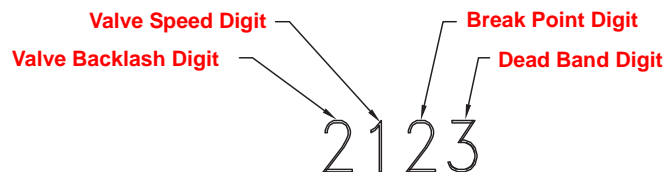

- **Valve Backlash digit:** This is the first digit in the valve calibration number.
- **Valve Speed digit:** This is the second digit in the valve calibration number.
- **Brake Point digit:** This is the third digit in the valve calibration number.
- **Dead Band digit:** This is the fourth digit in the valve calibration number.

### Valve Backlash Digit

This value controls the time of the first correction pulse after detecting a change in correction direction. The values range from 1 to 9, where 1 is for a short pulse and 9 is for a long pulse.

## Valve Speed Digit

This value controls the response time of the control valve motor. If you set the valve speed too fast, the valve will over correct and the system can start to oscillate. The following valves have specific values:

- Standard Control Valve: This valve has a range of values from 1 to 9, with 1 being slow and 9 being fast.
- Fast and Fast Close Control Valve: These valves have a range of values from 0 to 9, with 0 for fast and 9 for slow.

## Brake Point Digit

The Brake Point digit sets the percent away from the target rate at which the control valve starts to turn at a slower rate so that it does not overshoot the target rate. The values range from 0 to 9, where 0 is a 5% rate, 1 is a 10% rate, and 9 is a 90% rate.

## Dead Band Digit

The Dead Band digit is the allowable difference between the target rate and the actual application rate. The values range from 1 to 9, where 1 equals 1% difference and 9 equals 9% of the difference.

---

## *Calculating Rate Calibrations*

To ensure that you are delivering the proper amount of product to the fields, you must calibrate the rates for each product applied.

Use the following information to determine which spray nozzle(s) to use to apply the product:

- Nominal Application Pressure (PSI)
- Target Application Rate (GPA)
- Target Speed (MPH)
- Nozzle Spacing (Inches)

**Note:** Using the above information, you can calculate the gallons per minute (GPM), per nozzle using the following equation:

$$GPM = \frac{GPA \times mph \times inches}{5940}$$

### **For Example:**

GPA = 20, MPH = 5.2, Inches = 20 and assuming a target pressure of 30 PSI:

$$\frac{20 \times 5.2 \times 20}{5940} = 0.35$$

Therefore, you would need to select a tip that outputs a pressure of 30 PSI and 0.35 GPM. The chart below shows examples of different spray tips and configurations:

Tip Color	Tip No.		Liquid Pressure in PSI	Capacity Nozzle in GPM	Capacity Nozzle in oz./min	Gallons Per Acre- 20" Spacing			
	80 deg.	110 deg.				5 MPH	6 MPH	7 MPH	8 MPH
Yellow	XR8002	XR11002	15	.12	15	7.3	6.1	5.2	4.5
			20	.14	18	8.4	7.0	6.0	5.3
			30	.17	22	10.3	8.6	7.4	6.4
			40	.20	26	11.9	9.9	8.5	7.4
			60	.25	32	14.6	12.1	10.4	9.1
Blue	XR8003	XR11003	15	.18	23	10.9	9.1	7.8	6.8
			20	.21	27	12.6	10.5	9.0	7.9
			30	.26	33	15.4	12.9	11.0	9.7
			40	.30	38	17.8	14.9	12.7	11.1
			60	.37	47	22.0	18.2	15.6	13.6
Red	XR8004	XR11004	15	.24	31	14.5	12.1	10.4	9.1
			20	.28	36	16.8	14.0	12.0	10.5
			30	.35	45	21.0	17.2	14.7	12.9
			40	.40	51	24.0	19.8	17.0	14.9
			60	.49	63	29.0	24.0	21.0	18.2
Brown	XR8005	XR11005	15	.31	40	18.2	15.2	13.0	11.4
			20	.35	45	21.0	17.5	15.0	13.1
			30	.43	55	26.0	21.0	18.4	16.1
			40	.50	64	30.0	25.0	21.0	18.6
			60	.61	78	36.0	30.0	26.0	23.0

## *Verifying Flow Rate Limits*

The flow rate of spraying must be within the range of that specified for the flow meter. The following table displays the flow meter, range, and average calibration number.

<b>Flow Meter Model</b>	<b>Flow Range</b>	<b>Average Meter Cal Value</b>
RFM 5	0.05 to 5 GPM	5500
RFM 15 F	0.3 to 15 GPM	1750
RFM 60P/S	1 to 60 GPM	720
RFM 100	3 to 100 GPM	700
RFM 200/200 Poly	15 to 200 GPM	164
RFM 400	25 to 400 GPM	80

---

## *Calculating Meter Calibrations*

The flow meter calibration value is stamped on the tag that is attached to each flow meter. Use this number when programming Viper for the calibration.



## APPENDIX

# G

## Testing Extension Cables

### Speed Sensor Extension Cable

Verify that the system is in the Wheel Speed Sensor mode while testing the cable. Disconnect the extension cable from the Speed Sensor Assembly cable. Hold the extension cable connector so that the keyway is pointing in the 12 o'clock position as shown below.

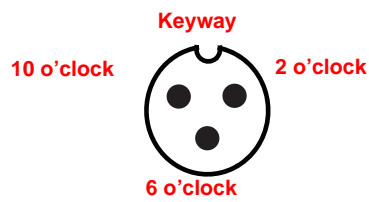

### Pin Designations and Voltage Readings

The following tables show the following pin designations and voltage readings.

Pin Location	Designation
2 o'clock	Power
10 o'clock	Ground
6 o'clock	Signal

Pin Connections	Voltage
10 o'clock to 6 o'clock	+5 Volts
10 o'clock to 2 o'clock	+5 Volts <sup>a</sup>

a. +12 Volts may be present if the cable is being used with a radar

**Note:** In a non-CAN system if a +5 voltage reading is not present, disconnect the Flow Meter cable. If the voltage reading is restored, test the Flow Meter cable as described in Appendix H, Testing the Flow Meter Cables.

## Testing the Speed Sensor Extension Cable

1. Press **Product Control**.

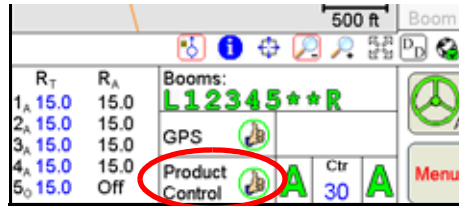

2. Press the **Miscellaneous** box. Enter 1000 as the Speed Cal and press **OK**.

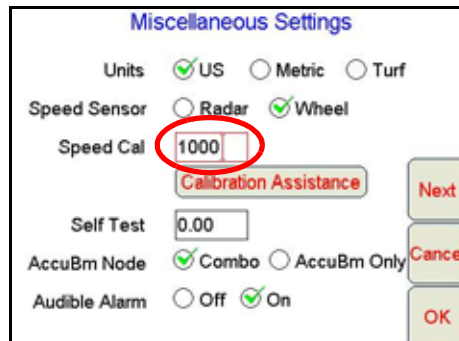

3. Press **OK** to return to the CAN Controller Status screen.
4. Press **Tally Registers**.
5. Press the **Reset** button next to the **Distance** box.

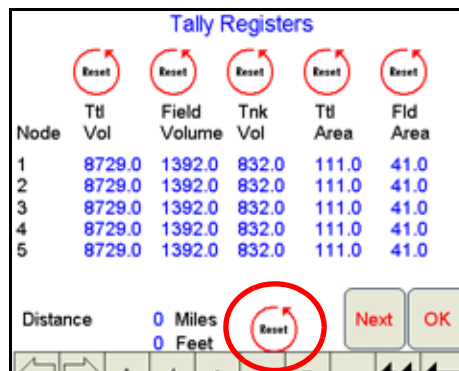

6. With a small jumper wire (or paper clip), short between the 10 o'clock and 6 o'clock sockets with a 'short-no-short' motion. Each time contact is made, the Distance total should increase by increments of 1 or more.
7. If the Distance total does not increase, remove the section of cable and repeat the test at the connector that is the next closest to the node. If the distance total now increments as you do the short-no-short test, replace the defective cable as required.
8. If no pulses are registered, perform the above voltage checks.
9. If all of the cables test 'good', replace the Speed Sensor.

**Note:** After testing is complete, re-enter the correct Speed Cal and Speed Sensor type before starting application.

# Flow Meter Extension Cables

Before starting this test, disconnect the flow meter cable from the flow meter. Hold the flow meter cable so that the keyway is pointing in the 12 o'clock position as shown below.

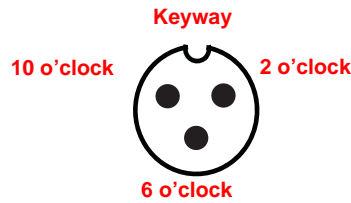

## Pin Designations and Voltage Readings

The following tables show the following pin designations and voltage readings.

Pin Location	Designation
2 o'clock	Ground
10 o'clock	Power
6 o'clock	Signal

  

Pin Connections	Voltage
2 o'clock to 6 o'clock	+5 Volts
10 o'clock to 2 o'clock	+5 Volts

**Note:** In a non-CAN system if a +5 voltage reading is not present, disconnect the Speed Sensor cable. If the voltage reading is restored, test the Speed Sensor cable as described in Appendix G, Testing the Speed Sensor Extension Cable.

## Testing the Flow Meter Cable

1. Press **Product Control**.

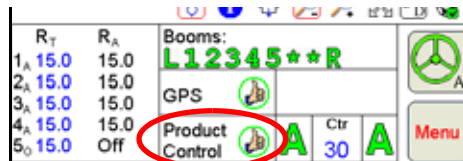

2. Press the **Data Box 2**.

- Enter the number '1' in the **Meter Cal** field and press **OK**.

**Node 1 Settings**

Tank Volume

Rate Cal

Rate +/-

Density

Spreader

Calibration Assistance

Next

Cancel

OK

- Press **Tally Registers**.
- Note the 'Ttl Vol' (total volume) column and the numbers for each node.

**Tally Registers**

Node	Ttl Vol	Field Volume	Tnk Vol	Ttl Area	Fid Area
1	8729.0	1392.0	832.0	111.0	41.0
2	8729.0	1392.0	832.0	111.0	41.0
3	8729.0	1392.0	832.0	111.0	41.0
4	8729.0	1392.0	832.0	111.0	41.0
5	8729.0	1392.0	832.0	111.0	41.0

Distance 0 Miles 0 Feet

Reset

Next

OK

- Turn the boom switches and the Master switch 'On'.
- With a small jumper wire (or paper clip), short between the 2 o'clock and 6 o'clock sockets with a 'short-no-short' motion. Each time contact is made, the Ttl Vol number should increase by increments of 1 or more.
- If the Ttl Vol total does not increase, remove the section of cable and repeat the test at the connector that is the next closest to the node. Replace the defective cable as required.
- Verify the pin connection and voltage from the previous chart.
- If all of the cables test 'good, replace the Flow Meter.

**Note:** After testing is complete, re-enter the correct Meter Cal before starting application.

## APPENDIX

# H

## *Updating CAN Nodes on the Viper Pro Console*

Viper Pro consoles with version 3.0 or higher software are capable of programming nodes on the CANbus directly through the Viper Pro console using a USB flash drive with the CAN Update program.

**Note:** *Before trying to update a CAN Node, make sure the node is communicating properly over the CANbus. If the node is not communicating properly, the Viper Pro will be unable to update the node.*

	<p style="text-align: center;"><b>NOTICE</b></p> <p>Updating a CAN Node erases the current settings in the node. To retain settings and calibration data, be sure to write down all settings stored by the node(s) being updated.</p>
--	---

The CAN Update program and node updates are available by contacting the Raven customer support center at 1-800-243-5435.

### To Update CAN Nodes

1. Start the Viper Pro and access the Program Selection Menu screen.

**Note:** *If the console is already powered up, touch the **Menu** button and select **Exit**. Select the **Exit to Menu** option on the Exit Viper screen.*

2. Insert the USB flash drive with the CAN Update program and required .hex files into an available USB port on the Viper Pro console.

3. On the Program Selection Menu screen, select the option labeled **“Update CAN Nodes”** to begin the CAN Update Program.

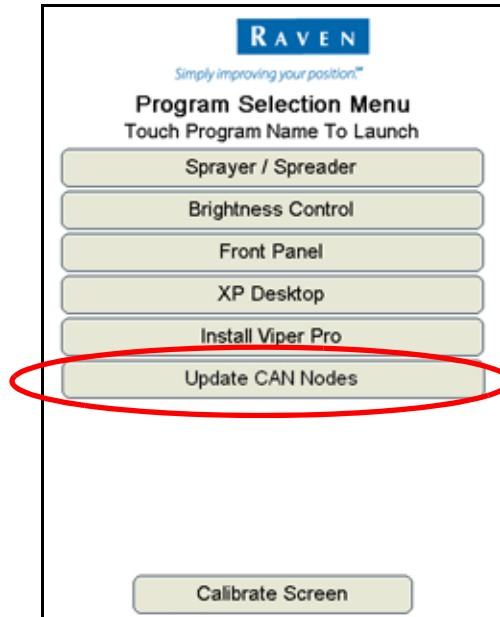

4. The Update CAN Nodes screen displays a list of available node updates. This screen also displays the firmware version to which each node will be updated if the update is applied.

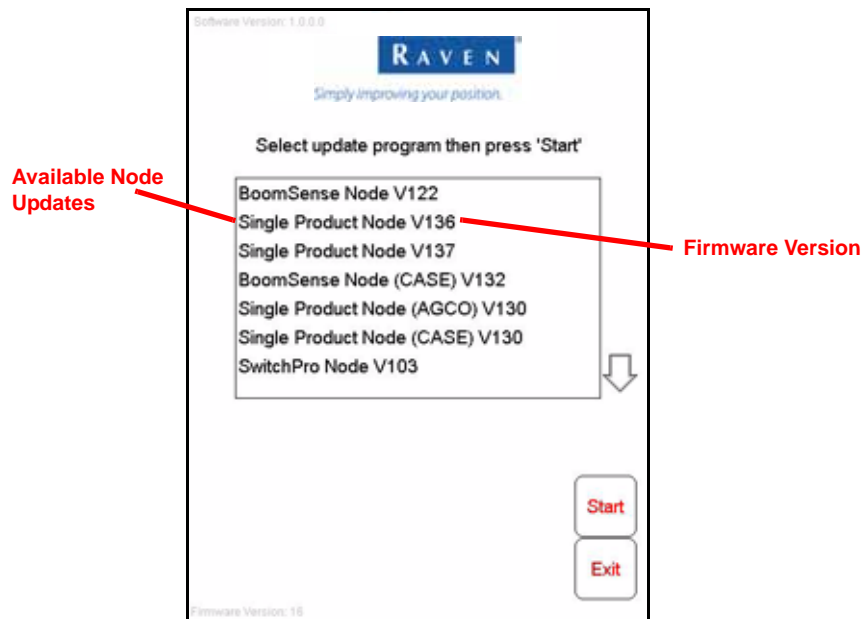

5. Touch the node update to apply.

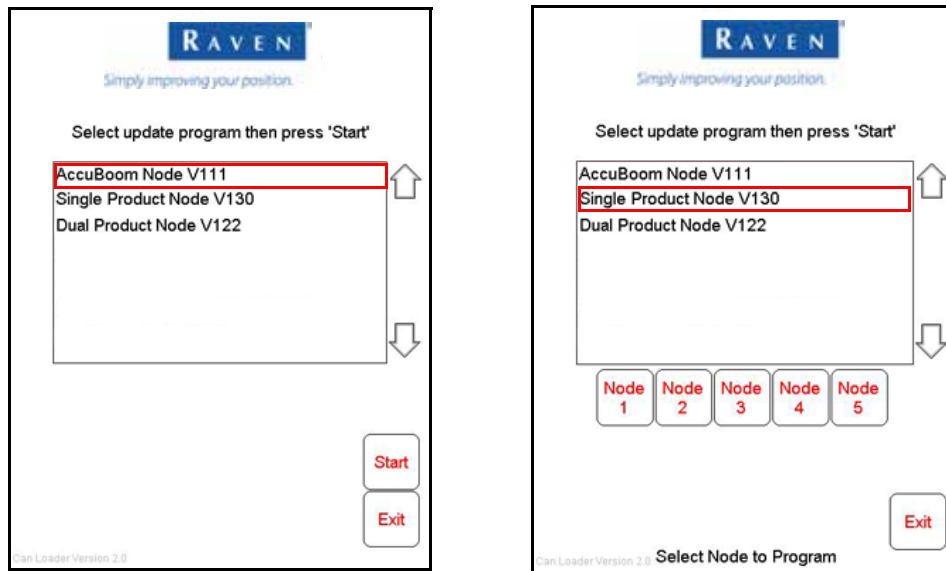

If a Product Control Node is selected, the Node 1 through Node 5 buttons will be displayed.

6. To start the node update:
  - a. If a non-product node (i.e. Boom Sense/Speed, AccuBoom, AutoBoom Node) is selected, press the **Start** button in the lower right corner of the screen to begin the update.
  - b. For Single Product Control Nodes, select the **Node** button corresponding to the product node to update.
  - c. For Dual Product Control Nodes, select the **Node** button corresponding to the *first* product controlled by the dual product node to begin updating the node.

**Note:** If the Viper Pro cannot communicate with the selected node, the CAN Update Program will display an error. Troubleshoot the node and retry the update.

7. The Viper Pro begins communicating with the selected update. If communication is successful, the Viper Pro will begin the update by erasing the node's memory.

**Note:** The Viper Pro may take several minutes to prepare and apply the software update to the node.

8. When the update is completed, Viper Pro will display a Programming Complete prompt. Touch the **OK** button to continue.

**Note:** If errors are encountered during the node update re-apply the node update.

9. To update other nodes via the Viper Pro CANbus repeat step 5 through 8.





## APPENDIX



# *Using the Front Panel Program with the Viper Pro System*

The Front Panel Program can be used to configure the Raven DGPS receivers, (110, 115, 210, and Phoenix 200, 310) only.

---

## *Initializing the Front Panel Program*

1. Press **Front Panel** from the Program Selection Menu.

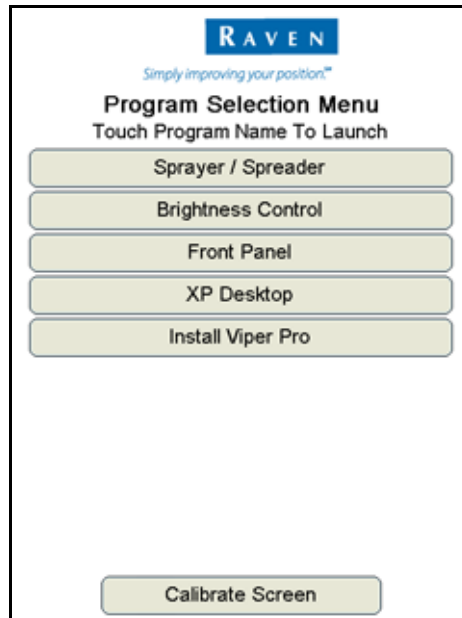

## Appendix I

---

2. After communication with receiver is established, you may navigate through the receiver by utilizing the buttons provided on the Viper touch screen, as well as using the Invicta Quick Start Guide (on the following page) as a reference.

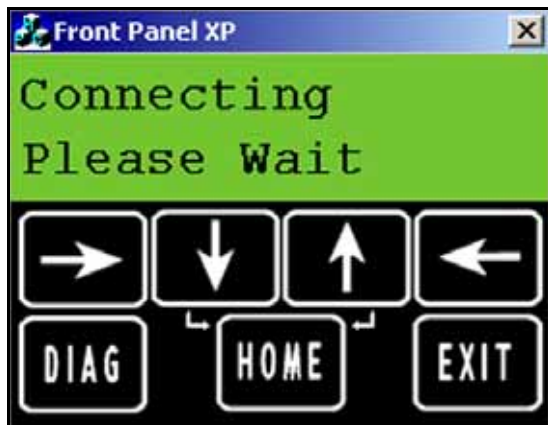
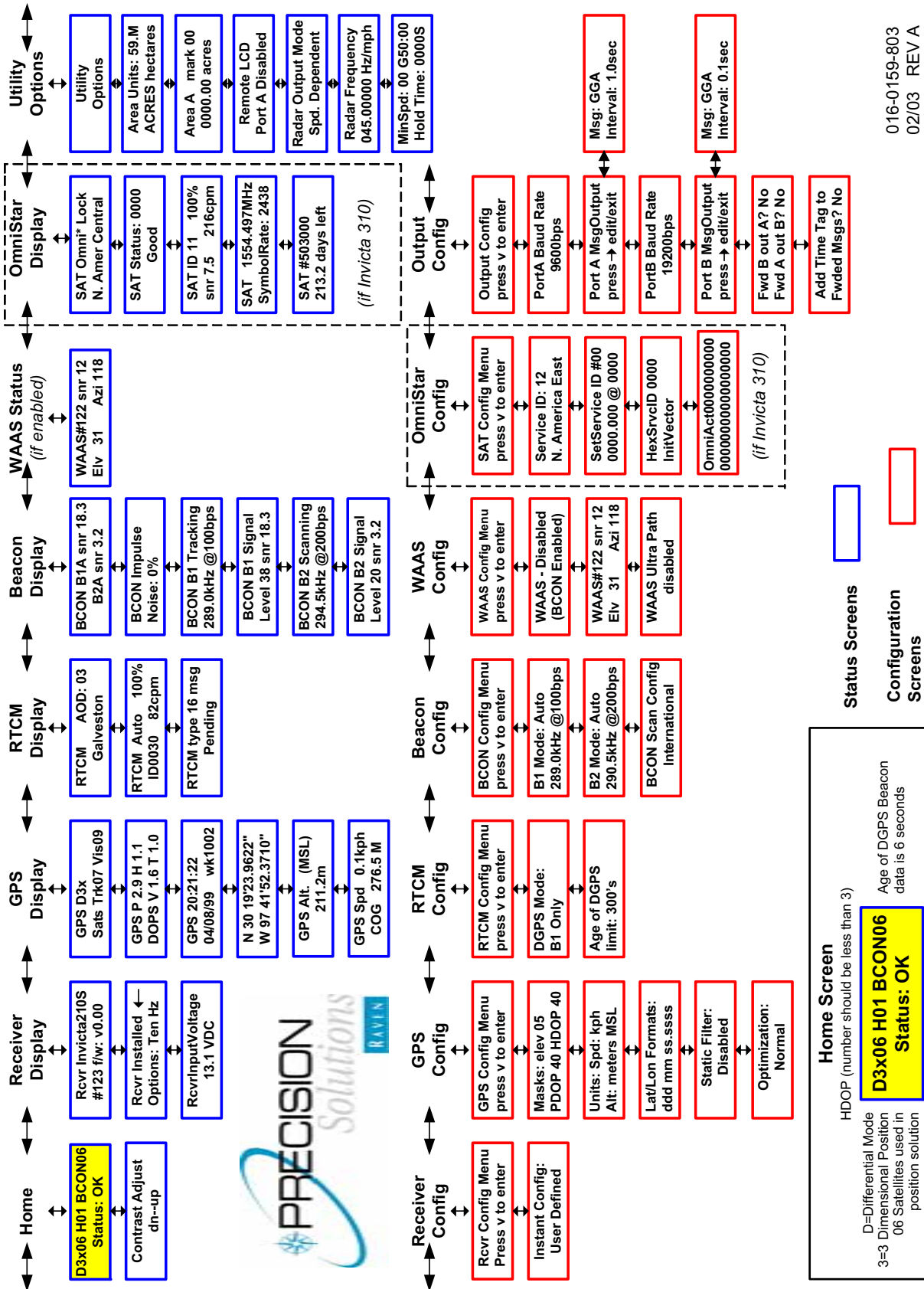

FIGURE 1. Invicta 210/310 Menu Structure



016-0159-803  
02/03 REV A



For spinner box machines, you can use a CAN control node capable of controlling spinner speed.

## Valve Type

Select the Valve Type for the machine you are using.

## Application

Select Spinner, for the application type. If Spinner does not show up on the application rate, you may not have a CAN control node capable of controlling spinner applications. Check the CAN control node and install a node that is capable of spinner control.

## Meter Cal

The machine should be configured with a magnetic pickup coil mounted near the bolt heads on the spinner. Calculate the meter cal by multiplying the number of pulses (bolt heads) per revolution by 10.

$$\text{MeterCal} = N \times 10$$

### **For Example:**

If the number of pulses per revolution is 4:

$$4 \times 10 = 40$$

then the value for the Meter Cal would be 40.

## Spreader Constant

The spreader constant should be set to 0.

## Rate Cal

The Rate Cal should be set to the desired RPM of the spinner.



## APPENDIX

# K

## *External Serial Rate Control*

The Viper Pro is capable of receiving serial rate information from an external source to control product application. One source of external serial rate information is the GreenSeeker® RT200 by NTech Industries, Inc. The Viper can be set up to receive serial rate information from the GreenSeeker® RT200 on the Viper auxiliary comm port. The rate information fed to the Viper is stored in the Rbin report and can be obtained by exporting the Shapefile from the Rbin data.

The Viper Pro can be configured either as a CANbus system or the Viper Pro can be connected to a Raven serial console. Set up the Viper product control for either configuration the same as you would without external serial rate control. Ensure that the Viper product control is configured properly before using an external serial rate source.

### *Setting up the Auxiliary Port for External Serial Rate Control*

1. Select **Menu**, then **Startup**, and **Comm Ports**. The GPS Comm Port Setup screen displays.
2. Press **Next**. The Auxiliary Comm Port screen displays.

Baud	Data Bits	Parity
<input type="radio"/> 1200	<input checked="" type="checkbox"/> 8	<input type="radio"/> Odd
<input type="radio"/> 4800	<input type="radio"/> 7	<input type="radio"/> Even
<input checked="" type="radio"/> 9600	Stop Bits	<input checked="" type="checkbox"/> None
<input type="radio"/> 19200	<input type="radio"/> 1	
<input type="radio"/> 38400	<input checked="" type="checkbox"/> 2	

Serial Rate

View Data    Prev    Cancel    OK

**Note:** If you have a serial console connected to the Viper, the Console Comm Port screen displays. Press **Next** to display the Auxiliary Comm Port screen.

3. Set the Auxiliary Comm Port settings to:
  - Baud = 9600
  - Data Bits = 8
  - Parity = None
  - Stop Bits = 2
4. Select the **Serial Rate** radio button.
5. Press **OK** to return to the main Viper screen.

## Connecting the GreenSeeker® RT200 to the Viper Pro

1. Connect the GreenSeeker® Interface Module to PDA Cable to the GreenSeeker® RT200.
2. Connect the DB9 connector on the GreenSeeker® Interface Module to the Auxiliary Comm Port connector on the Viper harness.

## Starting a Job with External Rate Control

**Note:** *External Serial Rate control is only available for Product #1. Make sure your system is configured to apply the desired product from the first product.*

1. Select **Menu**, then **Start Job**.
2. Select **New Job**.
3. Using the screen keyboard, enter a name for the job in the Job Name field. If no name is entered, the date and time are used for the job name.
4. Select the desired options from the list.
5. Press **Next**. If AccuBoom has been selected from the options list, select AccuBoom option desired and press **Next**.
6. If Swath Guidance has been selected from the option list, select the desired Swath Guidance pattern and press **Next**.
7. In the Product Selection screen, enter the number of products you are applying.
8. Press **Next**. The Product #1 Setup screen displays.

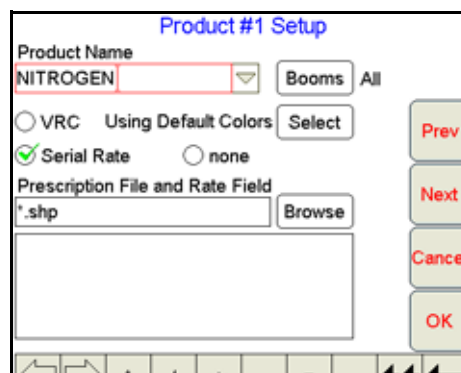

9. Using the screen keyboard, enter a product name in the Product Name field.
10. For External Serial Rate Control, select **Serial Rate**.

**Note:** *The Serial Rate selection will only appear if the Auxiliary Comm Port has been configured for Serial Rate. If the Serial Rate selection does not appear in the Product #1 setup screen, go back and set up the Auxiliary Comm Port for Serial Rate.*

11. Press **OK**.



---

## APPENDIX

# *Weather Station*



The Viper Pro is capable of reading information from an external weather station and recording this information into the Rbin file and Rbin report. The information being recorded to the Rbin includes:

- Temperature
- Relative Humidity
- Dew Point
- Barometric Pressure
- Wind Speed
- Wind Direction
- Wind Gust

The Viper Pro can only read information from one specific model of weather station. This unit is the WatchDog Sprayer Station Model 3349SS manufactured by Spectrum Technologies, Inc. This system can be ordered through your Raven distributor (P/N 117-0171-138).

For more information on this system contact Spectrum Technologies at: (800) 248-8873.

---

## *Weather Station Activation Key*

In order to use the weather station with the Viper Pro system, the Weather Module Activation Key (P/N 077-0180-030) must be purchased from your Raven distributor. Once the key has been purchased and registered on-line, the Activation key must be entered into the Viper Pro. See Chapter 2, *Installation, Start Up & Registration*, for help with registering and entering this information.

---

## Connecting the Weather Station

If the Viper Pro is connected to a CAN control system, the weather station must be connected to the CONSOLE connector on the Viper Pro Main Interface Cable (P/N 115-0171-746).

If the Viper Pro is connected to an external Raven serial controller, the weather station must be connected to COM 3 on the Viper Pro Auxiliary Interface cable (P/N 115-0171-745).

If the Viper Pro is using the Viper Pro Combination cable (P/N 115-0171-744), connect the weather station to the CONSOLE connector if using a CAN control system, or to the AUX connector if using an external Raven serial controller.

---

## Comm Port Configuration

Once the system is properly powered and cabled, and the activation key has been entered into the Viper Pro, the Viper communications port must be configured for the weather station.

1. Press **Menu / Setup / Comm Ports**.
2. Press the **Next** button until the Weather Module Setup page is displayed.

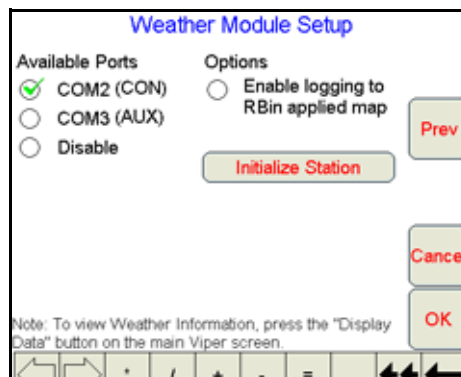

3. Select which comm port the station is connected to.

**Note:** *If you would like the weather information to be recorded to the Rbin file, which then can be exported as a shapefile, ensure the **Enable Logging to Rbin Applied Map** is checked. If this information is not needed, leave this un-checked, which will help conserve memory space on the internal storage.*

4. **Initialize Station** must be pressed one time to configure the weather station for use with the Viper Pro.
5. Press **OK** to complete the set-up.

To view weather information, press the **Display Data** button on the lower right hand side of the Viper, and then touch in the data area to toggle to the weather information.

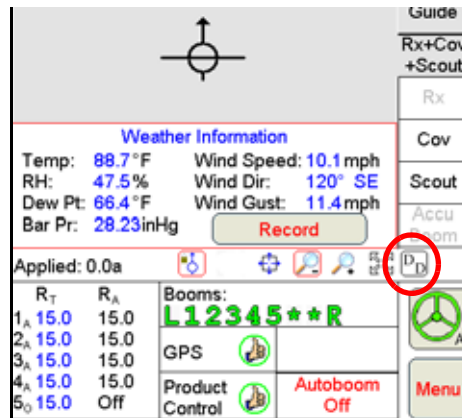

**Note:** If the Wind Direction heading displayed in the Weather Information does not appear as expected, re-initialize the Weather Station as described in the Comm Port Configuration section on page 232.

Press the **Record** button to log the current weather conditions into the Rbin Application Report. The record button will only display when in a job. The record button may be pressed as many times as desired during the job, but only the information from the last button press, before the job is closed will be recorded into the Rbin Application Report.



## APPENDIX

# M

## Wireless Communications & Remote Service

The Viper Pro console, with a Raven Field Hub, allows the operator to wirelessly transfer application data back to the home or office and transfer prescription data from the office to the field without the hassle of driving. This feature also adds the ability to allow service technicians and support specialists to remotely control the Viper Pro console, help is now just a touch away.

Via the Field Hub wireless router, the Viper Pro can also be used to keep up-to-date with the latest weather forecasts or crop prices from your favorite web sites while still managing product application.

**Note:** For instructions on installing and setting up your Raven Field Hub, refer to the Field Hub Quick Reference Guide (P/N 016-0171-238) provided with your wireless device.

### Wireless Communication Status

The status of wireless communications is displayed on the Viper Pro main screen in the tool bar below the map.

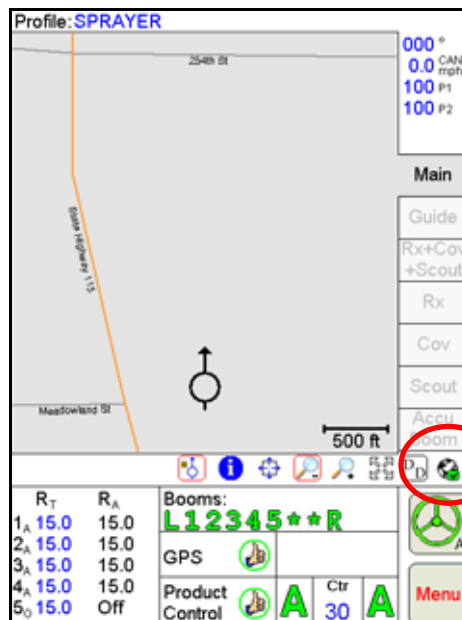





Wireless  
Communication  
Status Icon



## Appendix M



---

The following icons may be displayed in the wireless status area:

	<b>No Device Connected</b> - No supported wireless device is connected to the ethernet port on the Viper Pro. This icon is also displayed if wireless communication is unavailable or has been lost.
	<b>Communication OK</b> - The status of wireless communication is good and no errors or alarms are present.
	<b>Communication Error</b> - An error has occurred with wireless communication or during a file transfer.
	<b>Communication Lost or Unavailable</b> - This icon will be displayed if the registration process has not been successfully completed.

The wireless status symbols also display the file transfer status for any files to or from the Viper Pro console.

	<b>Sync In Progress</b> - The blue arrow symbol is displayed on the wireless status icon while the Viper Pro and the Slingshot™ site are synchronizing.
	<b>Files Received</b> - The envelope symbol is displayed on the wireless status icon when files have been received by the field computer. When this symbol is displayed, touch the icon to display the File Manager tab.

**Note:** When the  or  symbols are displayed, touching the Communication Status icon will display the Connection Status tab on the Wireless Status screen. Touching the status icon at any other time will display the Site Information tab.

---

## Wireless Status Screen

Touch the wireless status symbol displayed on the Viper Pro main screen to display the Wireless Status screen.

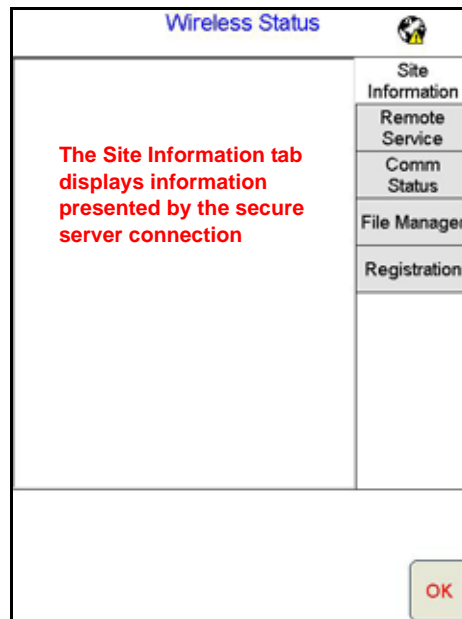

The Wireless Status screen displays information based on the tab selected on the right side of the screen. For details on the information displayed on each tab, refer to the following sections.

### Site Information Tab

Displays information from the Slingshot™ site.

### Remote Service Tab

The Remote Service feature allows a service technician to view and control a Viper Pro console in the field from his or her service location and assist the machine operator diagnose or troubleshoot the system.

**Note:** *The service technician will be able to determine whether a remote service session is necessary to assist with any issues encountered with the Viper Pro console. Contact your local Raven dealer or technical service provider before starting the remote service feature.*

To begin a remote service session:

1. Touch the Wireless Status icon on the Viper Pro main screen and select the Remote Service tab.
2. Touch the "Enable Remote Service" button. Have the code displayed on the screen available when contacting your local Raven dealer for support.
3. Read the code to the technician to allow them to view and control the Viper Pro system.

## Comm. Status Tab

The connection status tab displays the following information:

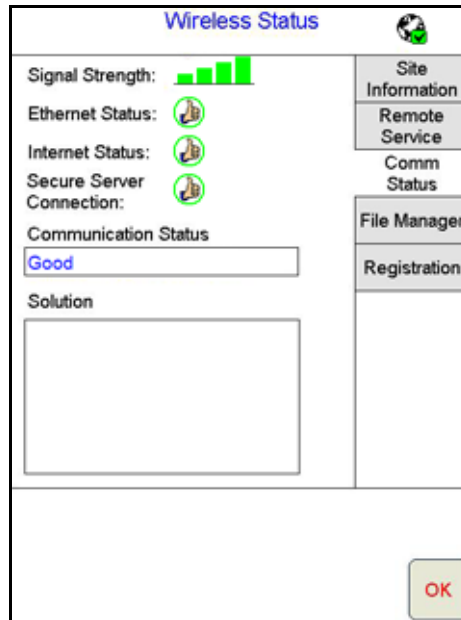

- **Current Alarms** - Any current communication errors or alerts are displayed in this area.
- **Signal Strength** - Displays bars to represent the current strength of wireless signal. Four bars represent a strong signal.
- **Ethernet Status** - Displays the status of the connection via the ethernet port on the back of the Viper Pro.
- **Internet Status** - View the status of communication with the world wide web in this area.
- **Secure Server Connection** - The connection status with the secure server is displayed in this area.

**Note:** *If any error conditions are encountered, the Communication Status screen will display possible solutions.*



---

## File Manager Tab

Access the File Manager tab to view a history of files recently transferred to or from the Viper Pro console.

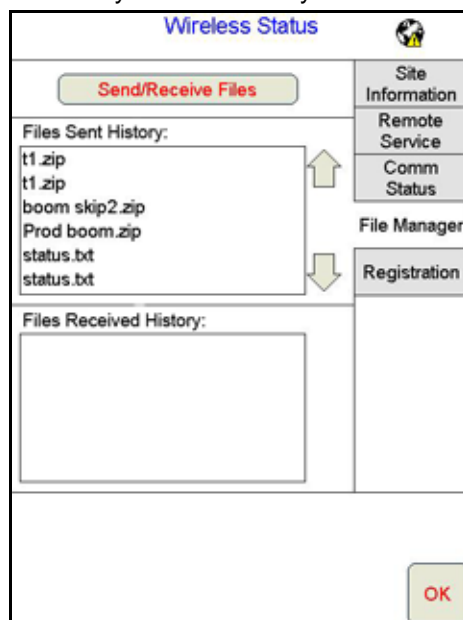

Use the up or down arrows to scroll through the history of files sent from, or received by, the Viper Pro.

Touch a file from one of the lists to view file information such as the file type and size as well as the date and time the file was sent or received.

## Registration Tab

The Registration tab is used to register the Field Hub with the Slingshot™ and activate the various features of wireless communication on the Viper Pro console.

**Note:** If the Field Hub has been registered previously, the Viper Pro will display the registration status above the "Registration Code" button. Touching the "Registration Code" button will display the Re-Registration Warning prompt below. To re-register the Field Hub, touch the "Yes" button and proceed with the registration instructions to re-register the Field Hub.

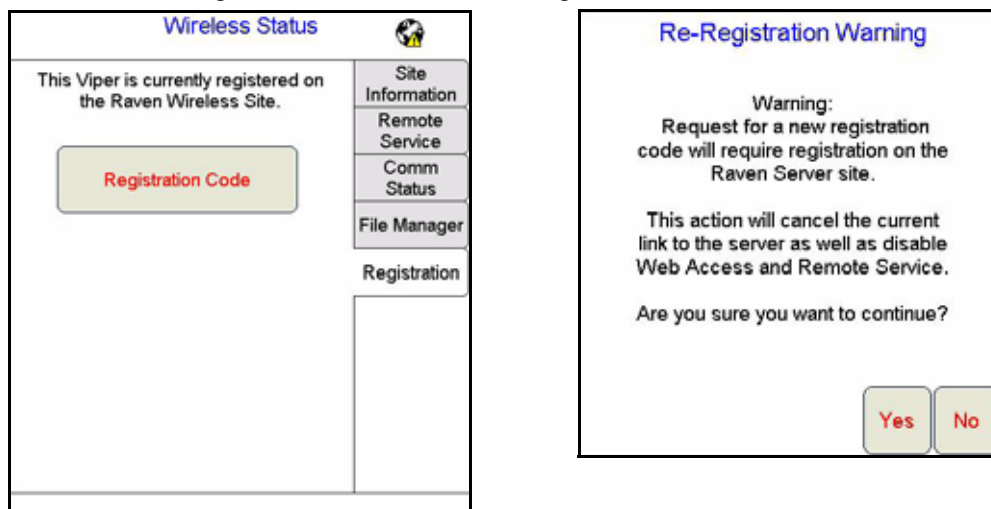

**To register:**

1. Touch the Wireless Status icon on the Viper Pro main screen and select the Registration tab.

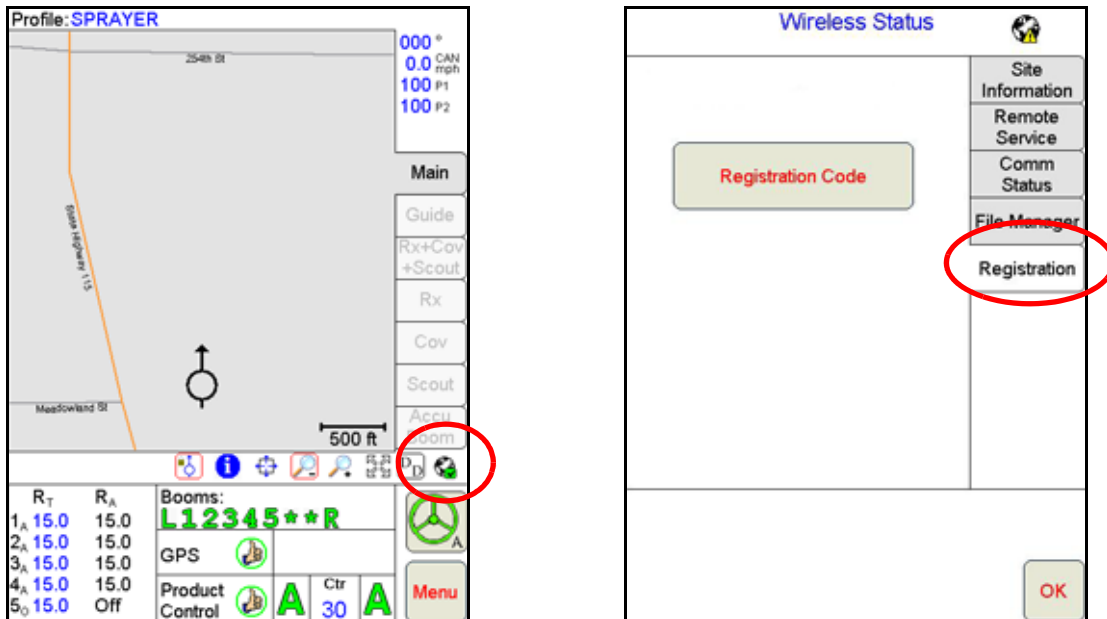

2. Touch the "Registration Code" button to get a four digit registration code from the Slingshot™ site.

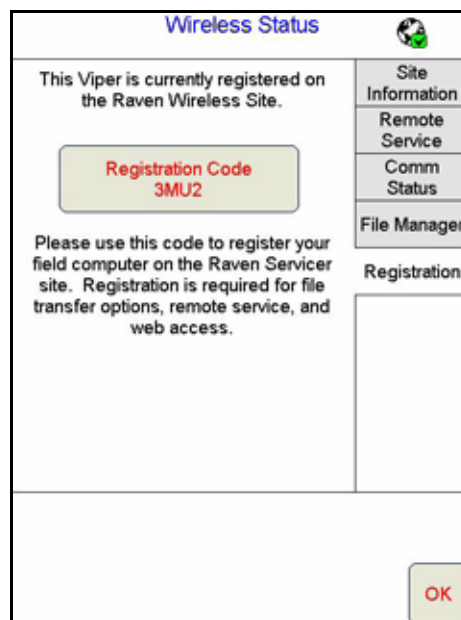

3. With the registration code, login to the Slingshot™ site.  
<http://slingshot.raveniat.net>
4. Select the "Register a Device" button.
5. Enter the required device information and the four digit registration code from the Viper Pro.

**Note:** Be sure to enable the Remote Service and Web Access features if desired (recommended). These features may be enabled later by accessing the Slingshot™ site.

6. Select the "Register" button.

---

**To test wireless access:**

1. Test the Wireless File Transfer feature by either one of the following:
  - Wait for the Viper Pro to automatically search for available files for transfer. This process may take up to five minutes.
  - Touch the File Manager tab on the Wireless Status screen and select the “Send/Receive Files” button at the top of the display.
2. If the Remote Service feature was enabled during registration, select the Remote Service tab and touch the “Enable Remote Service” button.
3. If a remote service session is enabled successfully, touch the button now labeled “Disable Remote Service.”
4. Exit the Wireless Status screen by pressing the “OK” button in the lower, right corner of the screen.
5. If the Web Access feature was enabled during registration, touch Menu>Web to open the Viper Pro internet browser and test the web access feature.



**A****A-B Lines** 154**About Button** 79**AccuBoom™**

- Aggressiveness Factor 134
- Boom Disable 133
- Changing Spray/No-Spray Default Colors 137
- Configuring AccuBoom™ Control 133
- Control 133, 134
- Control Setup 131
- Create No-Spray Map Method 136
- Enabling Override 135
- Load No-Spray Map Method 137
- Node 35
- Override 132
- Spray/No-Spray Maps 138
- Spray/No-Spray Zones 135
- Standard Method 136
- Tab 77
- Using 129
- Zero Rate Shut Off 133

**Active Matrix Transflective Touch Screen** 3**Advanced Settings** 104**Agitator** 39**Alarms** 54**Alternate Swath Pattern Button** 152**Alternate View Button** 153**Application**

- Area 50
- Rates 62
- Reports 117

**Application Reports**

- Applicator Information 119
- Creating 122
- Customer Information 117
- Field Information 118
- Ingredient Information 121
- Report Notes Information 121
- Vehicle Information 120
- Weather Information 119

**Area/Hour** 40**Audible Alarms** 35**AutoBoom™**

- Status Indicator 66
- Using 141

**Auto-Configuring a Raven DGPS Receiver** 96**Automatic File Maintenance** 167**Auxiliary Comm Port Setup** 97**B****Best Installation Practices** 22**Boom**

- Boom and Implement Setup 100
- Boom Cals 30
- Booms Area 63
- Calculating the Boom Width (Calibration) 205
- Mapping 102
- Tier Switching 115
- Tiered Booms 115

**C****Calculating**

- Boom Width (Calibration) for Liquid Applications 205
- Calibrations for Liquid and Granular Applications 211
- Speed Calibration 209
- Verification of Spreader Constant 207

**Calibrating the Pressure Transducer Using an Analog Gauge** 49**CAN (Controller Area Network)**

- Adding Nodes to the CAN System 26
- CAN Node Wiring 24
- CAN System Connections 25
- Detecting Nodes 27
- Initialization Results 27
- Node Off-line Errors 26
- Programming Nodes on the CANbus System 29
- Raven CAN System Installation 21
- Selecting a New Controller 27
- Setup 21
- Terminators 22
- Troubleshooting 194
- Wiring Power 23

**Care and Use** 6**Clone or Restore Settings** 168**Comm Port Setup**

- Console 97
- GPS 95

**Configuring the Scout Map** 85**Connecting the GreenSeeker® RT200 to the Viper Pro** 230**Console Comm Port Setup** 97**Controlling Spinner RPM** 227**Cov Tab** 73**Coverage Maps** 86

- Accessing Information 73
- Changing Colors 177
- Issues 190
- Setting Percentages and Colors 86

**Create Map From Field Boundary Method** 137**Creating an Application Report** 122**Current Heading** 59**D****Data Box 1** 36**Data Box 2** 39**Decimal Shift** 38**Deleting Street Maps** 84**DGPS Receiver Connection** 9**Display Data** 67, 126**Display Smoothing** 39**Display Units Configuration** 93**Downloading Street Maps** 83**Dual Flow %** 37**Dual Pressure** 49**E****Enabling**

- Manual Console Display 180
- Product Chaining 123

**Entering a Setting with no Analog Gauge** 50**Error Messages** 191**Exit Button** 78**Export Settings** 180

**Exporting Shapefiles** 175  
**External Lightbar** 99  
**External Serial Rate Control** 229

## F

**Fan/Pump Cal** 45  
**Fan/Pump RPM** 31  
**Field Boundaries** 70  
**Field Conditions** 118  
**File Maintenance** 81, 159  
    USB File Transfer 164  
**Flow/Shaft Alarm** 38  
**Front Panel** 5  
**Front Panel Program** 223

## G

**General Error Messages** 191  
**General Issues** 187

### GPS

    Comm Port Setup 95  
    DGPS Receiver Connection 9  
    Error Messages 193  
    Generic (Non-Raven) GPS Setup 95  
    Raven GPS Setup 96  
    Status Indicator 64

### Guidance

    Guide Menu Icon 153  
    Guide Tab 71  
    Patterns 147  
    Using the Guide Tab 151  
    Views 146

## I

**Importing a Field Boundary** 76  
**Installation, Start Up & Registration** 7  
**Introduction** 1

## J

### Jobs

    Adding to an Existing Job 114  
    Error Messages 192  
    Existing 114  
    Issues 189  
    New 108  
    Pausing 114  
    Restarting a Paused Job 114  
    Starting New Jobs 110  
    Starting with External Rate Control 230  
    Viewing an Existing Job 114

## L

**Language** 92  
    Change 92  
**Layout, Change** 178  
**LB Bright Button** 152  
**LB Dim Button** 152  
**Lightbar Display** 152  
**Loading**  
    A-B Lines 156

    Profiles 93  
**Local Settings** 92  
**Low Limit** 37  
**Low Tank** 37

## M

**Main Screen Features** 57  
**Main Tab** 69  
**Maintaining the Storage Memory** 204  
**Map Area** 60  
**Mapping the Booms** 103  
**Maps** 82  
**Marking a Field Boundary** 74  
**Max PW** 46  
**Menu** 78  
**Meter Cal/Density** 41  
**Min PW** 46  
**Misc Folder Sub-folders** 161  
**Miscellaneous Messages** 126  
**Miscellaneous Settings Area** 31  
**Mounting the Viper Pro Console** 9  
**Multi-Product VRA** 15

## N

**Navigating the Viper Pro Interface** 57  
**Node**  
    CAN Node Wiring Diagram 24  
    Off-line Errors 26  
**Node Version Information** 35  
**Nodes**  
    Adding Nodes to the CAN System 26  
    Detecting CANbus Nodes 27  
    Programming Nodes on the CANbus System 29  
**Nudge Feature** 157

## O

**Off Rate %** 37  
**Off-Swath Direction** 152  
**Off-Swath Distance** 152  
**On-Screen Lightbar, Configuring** 98  
**Override**  
    Zero-Speed 132  
**Override Sec** 132  
**Overview** 159

## P

**Percent Tier Disable** 115  
**Performing File Maintenance** 163  
**Power Connection** 10  
**Pre Set PW** 48  
**Preparing a USB Thumb Drive for File Maintenance** 160  
**Prescription (Rx) Maps** 87  
    Accessing the Rx Map Menu 88  
    Colors 89  
    Deleting a Color Template 91  
    Editing a Color Template 91  
    Error Messages 192  
    Map Issues 190

- Rx Look-Ahead 88
- Rx Tab 72
- Uploading via USB 164
- Pressure** 59
- Pressure Area** 49
- Product Application** 108
- Product Chaining** 110
  - Using 125
- Product Control Status** 66
- Product Information** 120
- Profile** 58
- Profile Configuration** 92
- Program Selection Menu** 13
- PW Freq** 48
- PWM** 40
  
- R**
- Rate +/-** 41
- Rate Cal** 41
- Ratio Rate** 48
- Rbin Viewer** 169
  - Change Language 179
  - Change Units of Measure 178
  - Downloading 169
  - Editing an Rbin Report 181
  - Installing 171
  - Opening an Rbin Report 173
  - Options 177
  - Select Coverage Display Options 176
  - Viewing Files 173
- Re-Addressing Product Nodes** 28
- Rear Panel** 6
- ReCal A-B Button** 153
- Recording Field Features** 85
- Registration Keys and Feature Activation** 82
- Reset A-B Button** 153
- Reset History** 184
- Rx**
  - See Prescription (Rx) Maps
- Rx+Cov+Scout Tab** 71
  
- S**
- Save A-B Button** 153
- Saving an A-B Line** 155
- Saving Profile Information** 92
- Scout Maps** 84
- Scout Tab** 74
- Screen Icons** 154
- Screen Tool Icons** 60
- Serial Communication Port Setup** 94
- Setting or Resetting Distance and Individual Nodes** 53
- Setting the Correct Operating Time Zone** 94
- Setting the Fixed Contour Pattern** 149
- Setting the Last Pass Pattern** 150
- Setting the Pivot Pattern** 150
- Setting the Straight AB Line Pattern** 147
- Setting the Unit of Measurement** 93
- Setting up Booms** 100
  
- Setting up the Auxiliary Port for External Serial Rate Control** 229
- Setting up the GPS Comm Port to a Non-Raven DGPS Receiver** 95
- Setup**
  - Button 81
  - Error Messages 191
  - Issues 188
- Simplified Spreader Constant Calibration** 42
- SmarTrax™ Status Indicator** 68
- Speed** 59
  - Cal 32
  - Display 31
  - Sensor 32
- Spray Tips** 115
- Spreader** 41
- Starting a Job with External Rate Control** 230
- Street Maps** 83
  - Downloading 83
  - Loading 84
- Swath**
  - Number 152
  - Patterns 147
- Swath Guidance** 109
- System Diagrams** 195
  - CAN AccuBoom™ with Serial Control Console and Viper Pro System Example 131
  - CAN AccuBoom™ with Viper Pro System Example 130
  - CAN Node Wiring 24
  - External Lightbar Connection 197
  - Sample CANbus System Diagram 25
  - Viper Pro Dual Product (Liquid/Granular) CAN Control System 200
  - Viper Pro Single Product (Liquid) CAN Control System 199
  - Viper Pro with External Lightbar 197
  - Viper Pro/Phoenix 200/RGL 600 Universal/SmarTrax Package 198
- System Status Icons** 64
  
- T**
- Tabs** 62, 69
- Tally Registers** 52
  - Resetting 53
- Tank Volume** 41
- Testing the Flow Meter Cables** 217
- Testing the Speed Sensor Extension Cable** 215
- Thumb Drive File Structure** 161
- Tiered Booms** 115
  - Enabling Tiered Booms 116
- Time Zone Configuration** 94
- Toolbar Options** 176
- Touch Screen Calibration** 14
- Troubleshooting the Viper Pro System** 187
- Turn-Off % Coverage** 132
- Turn-On/Turn-Off Look-Ahead** 132
  
- U**
- Understanding Viper Pro Files** 201
- Units** 32

## Index

---

Display Configuration 93

### **Updating** 219

### **USB File Maintenance** 164

Selecting a File Type to Work With 165  
Selecting An Operation To Perform 165  
Selecting Associated File Actions 166  
Selecting File Selection Method 166  
Selecting Source/Destination 165

### **USB File Transfer** 164

## V

### **Vacuum/Bin Alarm** 38

### **Valve**

Cal 45  
Cal 2 45  
Delay 48

### **Variable Rate Control (VRC)**

See Prescription (Rx) Maps

### **Vehicle Indicator** 153

### **Viper Pro**

Care and Use 6  
Configuring for Lightbar Guidance 98  
Features 15  
File Structure 201  
Guidance 143  
Mounting and Installation 9  
Mounting the Console 9  
Navigating the Interface 57  
Serial Console Connection 195  
Troubleshooting Information 187  
Understanding Files 201  
User Interface 3  
Using 107  
Using Front Panel 223

### **Vol/Min** 40

## W

### **Weather Station** 231

### **Wiring Power to a CANbus System** 23

## Z

### **Zero Rate Tolerance** 87

### **Zero Speed Shutoff** 38

### **Zoom Level** 153



**RAVEN**

# **RAVEN INDUSTRIES**

## **Limited Warranty**

---

### ***What Does this Warranty Cover?***

This warranty covers all defects in workmanship or materials in your Raven Applied Technology Product under normal use, maintenance, and service.

### ***How Long is the Coverage Period?***

Raven Applied Technology Products are covered by this warranty for 12 months after the date of purchase. This warranty coverage applies only to the original owner and is nontransferable.

### ***How Can I Get Service?***

Bring the defective part and proof of purchase to your Raven Dealer. If your Dealer agrees with the warranty claim, the Dealer will send the part and proof of purchase to their distributor or to Raven Industries for final approval.

### ***What Will Raven Industries Do?***

Upon confirmation of the warranty claim, Raven Industries will, at our discretion, repair or replace the defective part and pay for return freight.

### ***What is not Covered by this Warranty?***

Raven Industries will not assume any expense or liability for repairs made outside our facilities without written consent. Raven Industries is not responsible for damage to any associated equipment or products and will not be liable for loss of profit or other special damages. The obligation of this warranty is in lieu of all other warranties, expressed or implied, and no person or organization is authorized to assume any liability for Raven Industries.

Damages caused by normal wear and tear, misuse, abuse, neglect, accident, or improper installation and maintenance are not covered by this warranty.

**RAVEN**

Viper Pro™ (for software ver. 3.2)  
Installation & Operation Manual  
(P/N 016-0171-122 Rev D 12/09)

*Simply improving your position.™*



Raven Industries  
Applied Technology Division  
P.O. Box 5107  
Sioux Falls, SD 57117-5107

Toll Free (U.S. and Canada): (800)-243-5435  
or Outside the U.S. :1 605-575-0722

Fax: 605-331-0426

[www.ravenprecision.com](http://www.ravenprecision.com)  
[atdinfo@ravenind.com](mailto:atdinfo@ravenind.com)

Notice: This document and the information provided are the property of Raven Industries, Inc. and may only be used as authorized by Raven Industries, Inc. All rights reserved under copyright laws.